



OPERATING INSTRUCTIONS Personal Computer

Model No. **CF-U1** series

Contents

Getting Started

Introduction.....	2	Description of Parts.....	16
Read Me First.....	4	Preparation.....	20
(Precautions)		First-time Operation	25

Useful Information

On-screen Manual.....	31	Reinstalling Software	34
Handling and Maintenance.....	32		

Troubleshooting

Troubleshooting (Basic).....	36		
------------------------------	----	--	--

Appendix

LIMITED USE LICENSE AGREEMENT...46	LIMITED WARRANTY	54
Specifications	50	

**For further information about the computer, you can refer to the on-screen manual.
To access the on-screen manual → page 31 “On-screen Manual”**

Please read these instructions carefully before using this product, and save this manual for future use.

Getting Started

Useful Information

Troubleshooting

Appendix

Introduction

Thank you for purchasing this Panasonic product. For optimum performance and safety, please read these instructions carefully.

In these instructions, the names are referred as follows.

Windows 7

- “Genuine Windows® 7 Professional Service Pack 1” as “Windows” or “Windows 7”

Windows XP

- “Genuine Microsoft® Windows® XP Professional Service Pack 3” as “Windows” or “Windows XP”

■ Terms and illustrations in these instructions



 : Page in these Operating Instructions or in the Reference Manual.

 : Reference to the on-screen manuals.

CAUTION : Conditions that may result in minor or moderate injury.

NOTE : Useful and helpful information.

 : Press [] (Enter) key.

F_n +  (**Del**): Press and hold [Fn] key, and then press [] (Del) key.
This manual explains key operations based on QWERTY keyboard models for US-English.

The key combinations may differ when using QWERTY keyboards models other than US-English models. In such cases, look for the functions or icons (printed in blue) on your keyboard that correspond to the key functions in parenthesis in this manual, and press the key that is above or below these functions. You can easily operate this computer with one hand since Sticky Key function and Fn key lock function have been enabled at the time of purchase. (→  Reference Manual “Key Combinations”)

- To display the start menu with keyboard operations, press  (Windows) 3 times when Sticky Key function is enabled.

Click: Touch the screen with the stylus.

Right-click: **Windows 7**
Touch and hold with the stylus, or touch and select the right button of “touch pointer”.

Windows XP

- ① Click  on the notification area or on the desktop.
- ② Click the object you want to right-click.

Windows 7

 (Start) - [All Programs] :

Click  (Start), and then click [All Programs].
You may need to double-click in some cases.

Windows XP

[start] - [All Programs] :

Click [start], and then click [All Programs].

You may need to double-click in some cases.

- Some illustrations are simplified to help your understanding and may look different from the actual unit.
- If you do not log on as an administrator, you cannot use some functions or cannot display some screens.
- Refer for the latest information about optional products to the catalogs, etc.

■ Disclaimer

Computer specifications and manuals are subject to change without notice. Panasonic Corporation assumes no liability for damage incurred directly or indirectly from errors, omissions or discrepancies between the computer and the manuals.

■ Trademarks

Microsoft®, Windows® and the Windows logo are registered trademarks of Microsoft Corporation of the United States and/or other countries.

Intel, Core, Centrino and PROSet are either registered trademarks or trademarks of Intel Corporation.

SDHC Logo is a trademark.



Adobe, the Adobe logo and Adobe Reader are either registered trademarks or trademarks of Adobe Systems Incorporated in the United States and/or other countries.

Computrace® is a registered trademark of Absolute® Software Corp.

Bluetooth™ is a trademark owned by Bluetooth SIG, Inc., U.S.A. and licensed to Panasonic Corporation.

Names of products, brands, etc., appearing in this manual are trademarks or registered trademarks of their respective own companies.

Read Me First

Models for U.S.A.

Federal Communications Commission Radio Frequency Interference Statement

Note: This equipment has been tested and found to comply with the limits for a Class B digital device, pursuant to Part 15 of the FCC Rules. These limits are designed to provide reasonable protection against harmful interference in a residential installation. This equipment generates, uses and can radiate radio frequency energy and, if not installed and used in accordance with the instructions, may cause harmful interference to radio communications. However, there is no guarantee that interference will not occur in a particular installation. If this equipment does cause harmful interference to radio or television reception, which can be determined by turning the equipment off and on, the user is encouraged to try to correct the interference by one or more of the following measures:

- Reorient or relocate the receiving antenna.
- Increase the separation between the equipment and receiver.
- Connect the equipment into an outlet on a circuit different from that to which the receiver is connected.
- Consult the Panasonic Service Center or an experienced radio/TV technician for help.

Warning

To assure continued compliance, use only shielded interface cables when connecting to a computer or peripheral. Also, any changes or modifications not expressly approved by the party responsible for compliance could void the user's authority to operate this equipment.

This device complies with Part 15 of the FCC Rules. Operation is subject to the following two conditions:

- (1) This device may not cause harmful interference, and
- (2) This device must accept any interference received, including interference that may cause undesired operation.

FCC RF Exposure Warning:

<Only for model with wireless LAN/wireless WAN/Bluetooth>

- This equipment complies with FCC radiation exposure limits set forth for an uncontrolled environment.
- This equipment has been approved for portable operation, and does not require any minimum spacing be provided between antennas and all person's body.
- This equipment may not be co-located or operated with any other antenna or transmitter.

<Optional Car Mounter/Port Replicator>

This equipment is provided with external antenna connector(s) for connection to optional Car Mounter or Port Replicator for mobile external mounted antenna(s). External antenna(s) must be professionally installed and cannot exceed recommended maximum antenna gain as described in individual provided supplement instructions for wireless transmitters. Also, user must maintain minimum 20 cm spacing between external antenna(s) and all person's body (excluding extremities of hands, wrist and feet) during wireless modes of operation.

25-M-2

FCC RF Exposure Warning:

- This equipment is provided with external antenna connector(s) for connection to optional Car Mounter or Port Replicator for mobile external mounted antenna(s). External antenna(s) must be professionally installed and cannot exceed recommended maximum antenna gain as described in individual provided supplement instructions for wireless transmitters.

The maximum allowable antenna gain for the external WWAN base whip antenna for the cellular band is 7.50 dBi and PCS band is 3.50 dBi. Also, user must maintain minimum 20 cm spacing between external antenna(s) and all person's body (excluding extremities of hands, wrist and feet) during wireless modes of operation.

32-M-1-1

<Only for model with wireless LAN>

This product is restricted to indoor use due to its operation in the 5.15 to 5.25 GHz frequency range. FCC requires this product to be used indoors for the frequency range 5.15 to 5.25 GHz to reduce the potential for harmful interference to co-channel Mobile Satellite systems. High power radars are allocated as primary users of the 5.25 to 5.35 GHz and 5.65 to 5.85 GHz bands. These radar stations can cause interference with and /or damage this product.

25-M-W-2

Responsible Party:

Panasonic Corporation of North America

One Panasonic Way

Secaucus, NJ 07094

Tel No:1-800-LAPTOP5 (1-800-527-8675)

6-M-1

<For USA-California Only>

This product contains a CR Coin Cell Lithium Battery which contains Perchlorate Material - special handling may apply.

See www.dtsc.ca.gov/hazardouswaste/perchlorate/

38-M-1

Models for Canada

Canadian ICES-003

This Class B digital apparatus complies with Canadian ICES-003.

Cet appareil numérique de la classe B est conforme à la norme NMB-003 du Canada.

7-M-2

<Only for model with wireless LAN/Bluetooth/GPS>

Industry Canada

This product complies with RSS210 Industry Canada.

Operation is subject to the following two conditions;

- (1) this device may not cause interference, and
- (2) this device must accept any interference, including interference that may cause undesired operation of the device.

<Ne s'applique qu'aux modèles avec technologie Bluetooth/LAN sans fil/WAN sans fil/GPS>

Industrie Canada

Cet équipement est conforme à la norme CNR-210 d'Industrie Canada. Son fonctionnement est soumis aux deux conditions suivantes :

- (1) ce dispositif ne peut produire de brouillage, et
- (2) ce dispositif doit accepter le brouillage, y compris le brouillage pouvant entraîner le fonctionnement non désiré de l'appareil.

30-Ca-1-1

<Only for model with wireless LAN>

This product (local network devices) for the band 5150-5250 MHz is only indoor usage to reduce potential for harmful interference to co-channel Mobile Satellite systems.

High power radars are allocated as primary users (meaning they have priority) of 5250-5350 MHz and 5650-5850 MHz and these radars could cause interference and/or damage to LELAN devices.

Read Me First

<Ne s'applique qu'aux modèles avec technologie LAN sans fil>

Cet appareil (pour réseaux locaux radioélectriques) dans les bandes de fréquences 5150-5250 MHz est réservé à une utilisation à l'intérieur afin de réduire le risque d'interférence avec les systèmes satellites mobiles bicanaux.

Les radars forte puissance sont désignés comme étant les premiers utilisateurs (c'est-à-dire qu'ils ont la priorité) des bandes de fréquences 5250-5350 MHz et 5650-5850 MHz. Ces stations radars peuvent provoquer des interférences et/ou des dommages à ce périphérique.

30-Ca-2-1

This device has been designed to operate with the WWAN antenna having a maximum gain of 7.50 dB for the cellular band and 3.50 dB for the PCS band. WWAN antenna having a higher gain is strictly prohibited per regulations of Industry Canada. The Required antenna impedance is 50 ohms. To reduce potential radio interference to other users, the antenna type and its gain should be so chosen that the equivalent isotropically radiated power (EIRP) is not more than that required for successful communication.

Cet appareil est conçu pour opérer avec une antenne WWAN (réseau étendu sans fil) dont le gain maximum est fixé à 7.50 pour la bande cellulaire et à 3.50 pour la bande de service de communications personnelles (PCS). Les règlements d'Industrie Canada interdisent l'utilisation d'une antenne WWAN dont le gain serait supérieur à cette limite. L'antenne doit avoir une impédance de 50 ohms. Afin de réduire le risque d'interférence radioélectrique aux autres utilisateurs des bandes de fréquences, le type d'antenne et son gain doivent être tels que la puissance isotrope rayonnée équivalente (PIRE) n'est pas plus élevée que le niveau requis pour assurer la communication.

32-Ca-1-1

<Only for model with wireless LAN/wireless WAN/Bluetooth>

* This computer complies with Industry Canada radiation exposure limits set forth for an uncontrolled environment.

* This PC with WLAN and/or Bluetooth transmitters installed, has been approved for portable operation and does not require any minimum spacing be provided between antennas and all person's body.

<Ne s'applique qu'aux modèles avec technologie Bluetooth/LAN sans fil/WAN sans fil>

* Cet équipement est conforme aux limites d'exposition aux rayonnements d'Industrie Canada établies pour un environnement non contrôlé.

* Ce PC avec émetteurs WLAN et/ou Bluetooth a été approuvé à des fins d'opération mobile; aucun espace minimum entre les antennes et le corps de l'utilisateur n'est requis.

25-Ca-1

FOR USE WITH MODEL NO. : CF-AA1633A
POUR UTILISER AVEC MODÈLE : CF-AA1633A

20-Ca-1

Information to the User

<Only for model with wireless LAN/Bluetooth>

This product and your Health

This product, like other radio devices, emits radio frequency electromagnetic energy. The level of energy emitted by this product however is far much less than the electromagnetic energy emitted by wireless devices like for example mobile phones.

Because this product operates within the guidelines found in radio frequency safety standards and recommendations, we believe this product is safe for use by consumers. These standards and recommendations reflect the consensus of the scientific community and result from deliberations of panels and committees of scientists who continually review and interpret the extensive research literature. In some situations or environments, the use of this product may be restricted by the proprietor of the

- building or responsible representatives of the organization. These situations may for example include:
- Using this product on board of airplanes, or
 - In any other environment where the risk of interference to other devices or services is perceived or identified as harmful.

If you are uncertain of the policy that applies on the use of wireless devices in a specific organization or environment (e.g. airports), you are encouraged to ask for authorization to use this product prior to turning on the product.

Regulatory Information

We are not responsible for any radio or television interference caused by unauthorized modification of this product. The correction of interference caused by such unauthorized modification will be the responsibility of the user. We and its authorized resellers or distributors are not liable for damage or violation of government regulations that may arise from failing to comply with these guidelines.

26-M-1

Informations destinées aux utilisateurs

<Uniquement les modèles avec réseau local sans fil et/ou Bluetooth>

Ce produit et votre santé

Ce produit et votre santé

Ce produit, comme tout autre appareil radio, émet de l'énergie radioélectrique. Toutefois, la quantité d'énergie émise par ce produit est beaucoup moins importante que l'énergie radioélectrique émise par des appareils sans fil tels que les téléphones portables. L'utilisation de ce produit ne comporte aucun risque pour le consommateur du fait que cet appareil opère dans les limites des directives concernant les normes et les recommandations de sécurité sur les fréquences radio. Ces normes et recommandations reflètent le consensus de la communauté scientifique et résultent de délibérations de jurys et comités de scientifiques qui examinent et interprètent continuellement les nouveautés de la vaste littérature sur les recherches effectuées. Dans certaines situations ou environnements, l'utilisation de ce produit peut être restreinte par le propriétaire du bâtiment ou par les représentants responsables de l'organisation. Ces situations peuvent être les suivantes par exemple:

- A bord d'un avion, ou
- Dans tout autre environnement où les risques d'interférence sur d'autres appareils ou services sont perçus ou identifiables comme dangereux.

Si vous n'êtes pas sûr de la réglementation applicable à l'utilisation d'appareils sans fil dans une organisation ou un environnement spécifique, (par exemple dans un aéroport) nous vous invitons à demander l'autorisation d'utiliser ce produit avant sa mise en marche.

Informations concernant la réglementation

Nous déclinons toute responsabilité pour toute interférence radio ou télévision causée par des modifications non autorisées apportées à ce produit. La correction d'interférences causées par de telles modifications non autorisées sera la seule responsabilité de son utilisateur. Nous-mêmes, les revendeurs officiels et les distributeurs ne sommes pas responsable de tout dégât ou de toute violation des règlements de l'État pouvant découler du non-respect de ces directives.

26-F-1

Read Me First

Safety Precautions

<Only for model with wireless WAN>

The following safety precautions must be observed during all phases of the operation, usage, service or repair of any Personal Computer or Handheld Computer incorporating wireless WAN modem. Manufacturers of the cellular terminal are advised to convey the following safety information to users and operating personnel and to incorporate these guidelines into all manuals supplied with the product. Failure to comply with these precautions violates safety standards of design, manufacture and intended use of the product. Panasonic assumes no liability for customer failure to comply with these precautions.



When in a hospital or other health care facility, observe the restrictions on the use of mobiles. Switch Personal Computer or Handheld Computer incorporating wireless WAN modem off, if instructed to do so by the guidelines posted in sensitive areas. Medical equipment may be sensitive to RF energy. The operation of cardiac pacemakers, other implanted medical equipment and hearing aids can be affected by interference from Personal Computer or Handheld Computer incorporating wireless WAN modem placed close to the device. If in doubt about potential danger, contact the physician or the manufacturer of the device to verify that the equipment is properly shielded. Pacemaker patients are advised to keep their Personal Computer or Handheld Computer incorporating wireless WAN modem away from the pacemaker, while it is on.



Switch off Personal Computer or Handheld Computer incorporating wireless WAN modem before boarding an aircraft. Make sure it cannot be switched on inadvertently. The operation of wireless appliances in an aircraft is forbidden to prevent interference with communications systems. Failure to observe these instructions may lead to the suspension or denial of cellular services to the offender, legal action, or both.

For details on usage of this unit in aircrafts please consult and follow instruction provided by the airline.



Do not operate Personal Computer or Handheld Computer incorporating wireless WAN modem in the presence of flammable gases or fumes. Switch off the cellular terminal when you are near petrol stations, fuel depots, chemical plants or where blasting operations are in progress. Operation of any electrical equipment in potentially explosive atmospheres can constitute a safety hazard.



Your Personal Computer or Handheld Computer incorporating wireless WAN modem receives and transmits radio frequency energy while switched on. Remember that interference can occur if it is used close to TV sets, radios, computers or inadequately shielded equipment. Follow any special regulations and always switch off Personal Computer or Handheld Computer incorporating wireless WAN modem wherever forbidden, or when you suspect that it may cause interference or danger.



Road safety comes first! Do not use a Personal Computer or Handheld Computer incorporating wireless WAN modem while driving a vehicle. Do not place the computer with wireless WAN modem in an area where it could cause personal injury to the driver or passengers. It is recommended to stow the unit in the boot or secure stowage area while driving. Do not place the computer with wireless WAN modem in an area over an air bag or in the vicinity where an air bag may deploy. Air bags inflate with great force and if the computer with wireless WAN modem is placed in the air bag deployment area may be propelled with great force and cause serious injury to occupants of the vehicle.



IMPORTANT!

Personal Computer or Handheld Computer incorporating wireless WAN modem operate using radio signals and cellular networks cannot be guaranteed to connect in all conditions. Therefore, you should never rely solely upon any wireless device for essential communications, for example emergency calls.

Remember, in order to make or receive calls, Personal Computer or Handheld Computer incorporating wireless WAN modem must be switched on and in a service area with adequate cellular signal strength.

Some networks do not allow for emergency calls if certain network services or phone features are in use (e.g. lock functions, fixed dialing etc.). You may need to deactivate those features before you can make an emergency call. Some networks require that a valid SIM card be properly inserted in Personal Computer or Handheld Computer incorporating wireless WAN modem.

27-1-2

Lithium Battery / Pile au lithium

Lithium Battery!

This computer contains a lithium battery to enable the date, time, and other data to be stored. The battery should only be exchanged by authorized service personnel.

Warning!

A risk of explosion from incorrect installation or misapplication may possibly occur.

15-E-1

Pile au lithium!

Le micro-ordinateur renferme une pile au lithium qui permet de sauvegarder certaines données, notamment la date et l'heure. La pile ne doit être remplacée que par un technicien qualifié.

Danger!

Risque d'explosion en cas de non respect de cette mise en garde!

15-F-1

Read Me First

For Used in Motor Vehicle /Pour L'utilisation Dans Un Véhicule Motorisé

Warning: Notebook Computer may be installed in a motor vehicle and visible to the driver only if used to support vehicle related functions such as vehicle information, system control, rear or side observation and navigation. If used for entertainment purpose, such as television reception or video play, it must be installed to the rear of the driver's seat where it will not be visible, directly or indirectly, to the operator of the motor vehicle. Check with individual state/provincial laws to determine lawful use of this product while operating within a motor vehicle.

Avertissement : L'ordinateur bloc-notes peut être installé dans un véhicule motorisé et dans le champ de vision du conducteur uniquement en tant que dispositif d'aide aux fonctions du véhicule, comme par exemple pour fournir des informations sur le véhicule, comme dispositif de contrôle de système, pour l'observation à l'arrière ou sur les côtés du véhicule, ainsi que pour fournir de l'information routière. Pour toute utilisation à fin de divertissement, comme par exemple pour regarder la télévision ou jouer à des jeux vidéo, il doit être installé à l'arrière du siège du conducteur, en un emplacement où il ne sera pas visible, ni directement ni indirectement, pour le conducteur du véhicule motorisé. Vérifiez les lois fédérales et nationales qui régissent l'utilisation légale de cet appareil à l'intérieur d'un véhicule motorisé.

35-M-1

Information on Disposal in other Countries outside the European Union

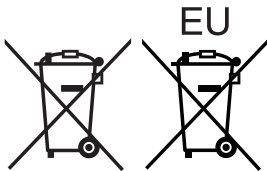

These symbols are only valid in the European Union.

If you wish to discard this product, please contact your local authorities or dealer and ask for the correct method of disposal.

53-M-1

USA Only: Disposal may be regulated in your community due to environmental considerations. For disposal or recycling information, please visit Panasonic website: <http://www.panasonic.com/environmental> or call 1-888-769-0149

65-M-2

<Only for model with 1D Barcode Reader>

Laser Devices

This equipment is using lasers that comply with US21CFR1040.10, 1040.11, EN 60825-1:1994+A2:2001+A1:2002 and IEC60825-1:1993+A1:1997+A2:2001 regulations.

The laser is a “Class 2” laser which is indicated on the label for this product.”

Class 2 laser readers use a low power, visible light diode. As with any very bright light source, such as the sun, the user should avoid staring directly into the light beam. Momentary exposure to a Class 2 laser is not known to be harmful.

Caution-Procedures other than those specified herein may result in hazardous radiation exposure.

Labeling/Marking

Top

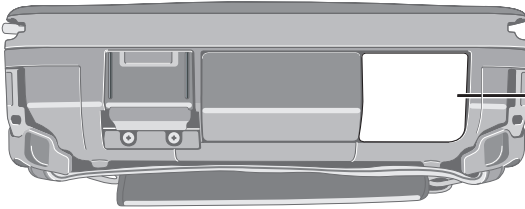

LASER LIGHT - DO NOT STARE INTO BEAM CLASS 2 LASER PRODUCT
LASERSTRAHLUNG - NICHT IN DEN STRAHL BLICKEN LASER KLASSE 2
LUMIERE LASER - NE PAS REGARDER DANS LE FAISCEAU APPAREIL A
LASER DE CLASSE 2 630 - 670nm, 1mW

Rear

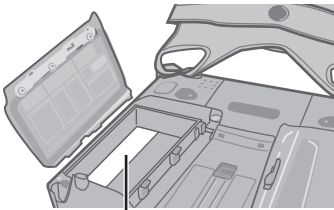

Complies with 21 CFR 1040.10 and 1040.11
except for deviations pursuant to Laser Notice No. 50, dated June 24, 2007.
EN60825-1:1994+ A1:2002 +A2:2001
IEC60825-1:1993+A1:1997+A2:2001

CAUTION - CLASS 2 LASER LIGHT WHEN OPEN, DO NOT STARE INTO THE BEAM.
ATTENTION - LUMIERE LASER EN CAS D'OUVERTURE. NE PAS REGARDER DANS LE FAISCEAU.
VORSICHT - LASERLICHT KLASSE 2, WENN ABDECKUNG GEÖFFNET. NICHT IN DEN STRAHL BLICKEN.

13-E-1

NOTE

- 2D barcode reader does not use laser light.

Read Me First

Precautions

THIS PRODUCT IS NOT INTENDED FOR USE AS, OR AS PART OF, NUCLEAR EQUIPMENT/SYSTEMS, AIR TRAFFIC CONTROL EQUIPMENT/SYSTEMS, AIRCRAFT COCKPIT EQUIPMENT/SYSTEMS¹, MEDICAL DEVICES OR ACCESSORIES², LIFE SUPPORT SYSTEMS OR OTHER EQUIPMENTS/DEVICES/SYSTEMS THAT ARE INVOLVED WITH ENSURING HUMAN LIFE OR SAFETY. PANASONIC WILL NOT BE RESPONSIBLE FOR ANY LIABILITY RESULTING FROM THE USE OF THIS PRODUCT ARISING OUT OF THE FOREGOING USES.

¹ AIRCRAFT COCKPIT EQUIPMENT/SYSTEMS include Class 2 Electronic Flight Bag (EFB) Systems and Class 1 EFB Systems when used during critical phases of flight (e.g., during take-off and landing) and/or mounted on to the aircraft. Class 1 EFB Systems and 2 EFB Systems are defined by FAA: AC (Advisory Circular) 120-76A or JAA: JAA TGL (Temporary Guidance Leaflets) No.36.

² As defined by the European Medical Device Directive (MDD) 93/42/EEC.

Panasonic cannot guarantee any specifications, technologies, reliability, safety (e.g. Flammability/Smoke/Toxicity/Radio Frequency Emission, etc) requirements related to aviation standards and medical equipment standards that differ from the specifications of our COTS (Commercial-Off-The-Shelf) products.

The CF-U1 was developed based on thorough research into the real-world portable computing environments. Exhaustive pursuit of usability and reliability under harsh conditions led to innovations such as the magnesium alloy exterior, vibration damped flash memory disk drive, flexible internal connections. The CF-U1's outstanding engineering has been tested using the strict MIL-STD-810F (for vibration and shock) and IP (for dust and water) based procedures. As with any portable computer device precautions should be taken to avoid any damage. The following usage and handling procedures are recommended.

Before putting the computer away, be sure to wipe off any moisture.

If a Malfunction or Trouble Occurs, Immediately Stop Use

If a Malfunction Occurs, Immediately Unplug the AC Plug and the Battery Pack

- This product is damaged
- Foreign object inside this product
- Smoke emitted
- Unusual smell emitted
- Unusually hot

Continuing to use this product while any of the above conditions are present may result in fire or electric shock.

- If a malfunction or trouble occurs, immediately turn the power off and unplug the AC plug, and then remove the battery pack. Then contact your technical support office for repair.

Do Not Touch This Product and Cable When It Starts Thundering

Electric shock may result.

Do Not Connect the AC Adaptor to a Power Source Other Than a Standard Household AC Outlet

Otherwise, a fire due to overheating may result. Connecting to a DC/AC converter (inverter) may damage the AC adaptor. On an airplane, only connect the AC adaptor/charger to an AC outlet specifically approved for such use.

Do Not Do Anything That May Damage the AC Cord, the AC Plug, or the AC Adaptor

Do not damage or modify the cord, place it near hot tools, bend, twist, or pull it forcefully, place heavy objects on it, or bundle it tightly.

Continuing to use a damaged cord may result in fire, short circuit, or electric shock.

Do Not Pull or Insert the AC Plug If Your Hands Are Wet

Electric shock may result.

Clean Dust and Other Debris of the AC Plug Regularly

If dust or other debris accumulates on the plug, humidity, etc. may cause a defect in the insulation, which may result in a fire.

- Pull the plug, and wipe it with a dry cloth. Pull the plug if the computer is not being used for a long period of time.

Insert the AC Plug Completely

If the plug is not inserted completely, fire due to overheating or electric shock may result.

- Do not use a damaged plug or loose AC outlet.

Close the Connector Cover Tightly When Using This Product Where Is a Lot of Water, Moisture, Steam, Dust, Oily Vapors, etc.

The entry of foreign matter may cause a fire or electric shocks.

- If foreign matter has found its way inside, immediately turn the power off and unplug the AC cord, and then remove the battery pack. Then contact your technical support office.

Do Not Disassemble This Product

You may receive an electric shock, or foreign matter may enter and result in a fire.

Keep SD Memory Cards Away from Infants and Small Children

Accidental swallowing will result in bodily injury.

- In the event of accidental swallowing, see a doctor immediately.

Do Not Place This Product on Unstable Surfaces

If balance is lost, this product may fall over or drop, resulting in an injury.

Avoid Stacking

If balance is lost, this product may fall over or drop, resulting in an injury.

Do Not Leave This Product in High Temperature Environment for a Long Period of Time

Leaving this product where it will be exposed to extremely high temperatures such as near fire or in direct sunlight may deform the cabinet and/or cause trouble in the internal parts. Continued use in such a resulting condition may lead to short-circuiting or insulation defects, etc. which may in turn lead to a fire or electric shocks.

Hold the Plug When Unplugging the AC Plug

Pulling on the cord may damage the cord, resulting in a fire or electric shock.

Do Not Move This Product While the AC Plug Is Connected

The AC cord may be damaged, resulting in fire or electric shock.

- If the AC cord is damaged, unplug the AC plug immediately.

Use Only the Specified AC Adaptor With This Product

Using an AC adaptor other than the one supplied (attached to your product or supplied by Panasonic) may result in a fire.

Do Not Subject the AC Adaptor to Any Strong Impact

Using the AC adaptor after a strong impact such as being dropped may result in electric shock, short circuit, or fire.

Take a Break of 10-15 Minutes Every Hour

Using this product for long periods of time may have detrimental health effects on the eyes or hands.

Do Not Turn the Volume Up to Loud When Using Headphones

Listening at high volumes that overstimulate the ear for long periods of time may result in loss of hearing.

Do Not Use with Exposing the Skin to This Product for a Long Period of Time

Using this product with exposing the skin to the heat source of this product or AC adaptor for a long period of time can cause a low-temperature burn.

Read Me First

Do Not Expose the Skin To This Product When Using the Product In A Hot Or Cold Environment

Burns, low-temperature burns, or frostbite may result.

- When it is necessary to expose the skin to this product such as to scan a fingerprint, perform the operation in the shortest time possible.
- Do not place the computer near a television or radio receiver.
- Keep the computer away from magnets. Data stored on the flash memo-

ry may be lost.

- This computer is not intended for the display of images for use in medical diagnosis.
- This computer is not intended for a use with connection of medical equipment for the purpose of medical diagnosis.
- Panasonic shall not be liable for loss of data or other incidental or consequential damages resulting from the use of this product.

Precautions (Battery Pack)

Do Not Use with Any Other Product

The battery pack is rechargeable and was intended for the specified product. If it is used with a product other than the one for which it was designed, electrolyte leakage, generation of heat, ignition or rupture may result.

Do Not Charge the Battery Using Methods Other Than Those Specified

If the battery is not charged using one of the specified methods, electrolyte leakage, generation of heat, ignition or rupture may result.

Do Not Throw the Battery Pack into a Fire or Expose It to Excessive Heat

Generation of heat, ignition or rupture may result.

Avoid Extreme Heat (Near the Fire, in Direct Sunlight, for Example)

Electrolyte leakage, generation of heat, ignition or rupture may result.

Do Not Insert Sharp Objects into the Battery Pack, Expose It to Bumps or Shocks, Disassemble, or Modify It

Electrolyte leakage, generation of heat, ignition or rupture may result.

- If this product is subjected to a strong impact, stop using it immediately.

Do Not Short the Positive (+) and Negative (-) Contacts

Generation of heat, ignition or rupture may result.

- Do not place the battery pack togeth-

er with articles such as necklaces or hairpins when carrying or storing.

Do Not Use This Product with a Battery Pack Other Than the One Specified

Use only the specified battery pack (CF-VZSU53W) with your product. Use of battery packs other than those manufactured and supplied by Panasonic may present a safety hazard (generation of heat, ignition or rupture).

When the battery pack has deteriorated, replace it with a new one



Continued use of a damaged battery pack may result in heat generation, ignition or battery rupture.

- Do not touch the terminals on the battery pack. The battery pack may no longer function properly if the contacts are dirty or damaged.
- Do not expose the battery pack to water, or allow it to become wet.
- If the battery pack will not be used for a long period of time (a month or more), charge or discharge (use) the battery pack until the remaining battery level becomes 30% to 40% and store it in a cool, dry place.
- This computer prevents overcharging of the battery by recharging only when the remaining power is less than approx. 95% of capacity.
- The battery pack is not charged when the computer is first purchased. Be sure to charge it before using it for

the first time. When the AC adaptor is connected to the computer, charging begins automatically.

- Should the battery leak and the fluid get into your eyes, do not rub your eyes. Immediately flush your eyes with clear water and see a doctor for medical treatment as soon as possible.

NOTE

- The battery pack may become warm during recharging or normal use. This is completely normal.
- Recharging will not commence if internal temperature of the battery pack is outside of the allowable temperature range (0 °C to 50 °C {32 °F to 122 °F}).
(→  *Reference Manual* “Battery Power”) Once the allowable range requirement is satisfied, charging begins automatically. Note that the recharging time varies based on the usage conditions. (Recharging takes longer than usual when the temperature is 10 °C {50 °F} or below.)
- In high-temperature environments, the battery takes longer to fully recharge and the operating time is shorter. Only use the computer within the allowable temperature range.
- This computer has a high temperature mode function that prevents the degradation of the battery in high temperature environments.
(→  *Reference Manual* “Battery Power”) A level corresponding to a

100% charge for high temperature mode is approximately equivalent to an 80% charge level for normal temperature mode.

- The battery pack is a consumable item. If the amount of time the computer can be run by using a particular battery pack becomes dramatically shorter and repeated recharging does not restore its performance, the battery pack should be replaced with a new one.
- When transporting a spare battery inside a package, briefcase, etc., it is recommended that it be placed in a plastic bag so that its contacts are protected.
- Always power off the computer when it is not in use. Leaving the computer on when the AC adaptor is not connected will exhaust the remaining battery capacity.

CAUTION:

Risk of Explosion if Battery is replaced by an Incorrect Type.

Dispose of Used Batteries According to the Instructions.

58-E-1

ATTENTION:

Il y a risque d'explosion si la batterie est remplacée par une batterie de type incorrect.

Mettre au rebut les batteries usagées conformément aux instructions.

58-F-1



A lithium ion battery that is recyclable powers the product you have purchased.

Please call 1-800-8-BATTERY for information on how to recycle this battery.

L'appareil que vous vous êtes procuré est alimenté par une batterie au lithium-ion.

Pour des renseignements sur le recyclage de la batterie, veuillez composer le 1-800-8-BATTERY

48-M-1

Description of Parts



A: LCD

→ *Reference Manual*
“Touchscreen”

B: Scroll Button

You can scroll the screen, etc. This works as a mouse wheel.

→ *Reference Manual*
“Hardware Button Setting”

C: LED Indicator

: Wireless ready
This indicator lights when Wireless LAN, Bluetooth, and/or Wireless WAN are connected and ready. It does not necessarily indicate the On/Off condition of the wireless connection.

→ *Reference Manual*
“Disabling/Enabling
Wireless Communication”

: Wireless WAN status
<Only for model with wireless WAN>
→ Refer to the instruction manual of the wireless device.

1 : Battery 1 status
→ *Reference Manual*
“Battery Power”

D: Zoom Button

→ *Reference Manual*
“Zoom Function”

E: Keyboard

: [Back space] Key

You can select whether to switch the [Del] Key functions with the Key functions, and vice versa on the internal keyboard.

: [Enter] Key

: [Shift] Key

→ *Reference Manual*
“Setup Utility”

F: Ambient Light Sensor

Backlight will be turned off with a bright environment so the battery operation time becomes long. It doesn't function when concealing.

→ *Reference Manual*
“Setup Utility”

G: Power Switch

H: Application Buttons

You can register your favorite application files to 4 buttons respectively.

→ *Reference Manual*
“Hardware Button Setting”
“Setup Utility”

I: LED Indicator

- 1 : Power status
 - Off: Power off/Hibernation
 - Green: Power on
 - Blinking green

: Sleep

: Standby

: Flash memory status

2 : Battery 2 status

→ *Reference Manual*
“Battery Power”

Right side

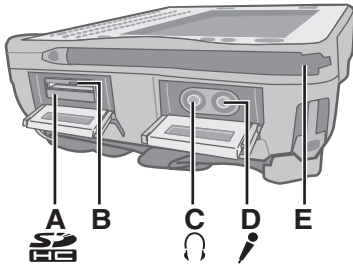

A: SD Memory Card Slot

→  *Reference Manual*
“SD Memory Card”

B: SD Memory Card Indicator

(Blinking: During access)
→  *Reference Manual*
“SD Memory Card”

C: Headphone Jack

You can connect headphones or amplified speakers. When they are connected, audio from the internal speakers is not heard.

D: Microphone Jack

A condenser microphone can be used. If other types of microphones are used, audio input may not be possible, or malfunctions may occur as a result.

- When recording in stereo using a stereo microphone:

Windows 7

Click  (Start) - [Control Panel] - [Hardware and Sound] - [Sound] - [Recording] - [Microphone] - [Properties], and then remove a check mark for [Enable Audio enhancements] in [Advanced].

Windows XP

Click [start] - [All Programs] - [SoundMAX] - [Control Panel] and select [Microphone], and then add a check mark for [No Filtering] in [Microphone Enhancements].

- When using a monaural microphone with a 2-terminal plug:

Windows 7

Click  (Start) - [Control Panel] - [Hardware and Sound] - [Sound] - [Recording] - [Microphone] - [Properties], and then add a check mark for [Enable Audio enhancements] in [Advanced]. Otherwise, only audio on the left track will be recorded.

Windows XP

Click [start] - [All Programs] - [SoundMAX] - [Control Panel] and select [Microphone], and then add a check mark for [Voice Recording] in [Microphone Enhancements]. Otherwise, only audio on the left track will be recorded.

E: Stylus Holder (right side)

Description of Parts

Left side

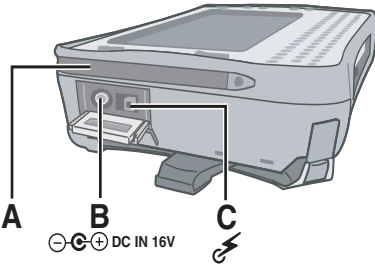

Top

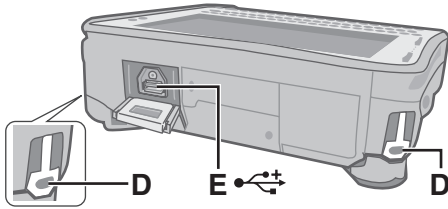

Rear and Bottom

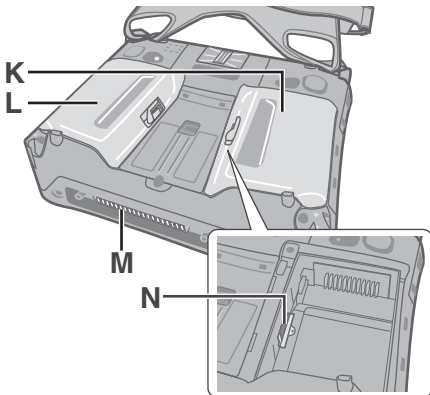
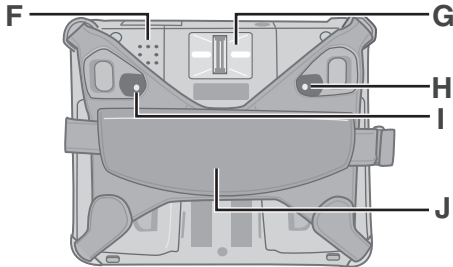

A: Stylus Holder (left side)

B: DC-IN Jack

C: Wireless Switch

→ *Reference Manual*
“Disabling/Enabling Wireless Communication”

D: Security Lock (2 holes)

A Kensington cable can be connected.

For further information, read the manual that comes with the cable.

E: USB 2.0 Port

→ *Reference Manual* “USB Devices”

F: Speaker

→ *Reference Manual*
“Key Combinations”

G: Fingerprint Reader

<Only for model with Fingerprint Reader>

→ *Reference Manual*
“Fingerprint Reader”

H: Battery 1 Indicator

I: Battery 2 Indicator

→ *Reference Manual* “Battery Power”

J: Hand Strap

K: Battery 1 Case

L: Battery 2 Case

→ *Reference Manual* “Battery Power”

M: Expansion Bus Connector

→ *Reference Manual* “Cradle / Mini Port Replicator”

N: SIM Card Slot

<Only for model with wireless WAN>
To open the battery cover → page 20 “Inserting the Battery Packs”.

Inside

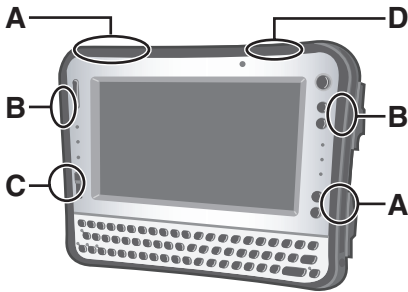

A: Wireless WAN antenna

<Only for model with wireless WAN>
Wireless WAN is not available depending on a model.

B: Wireless LAN antenna

<Only for model with wireless LAN>

→ *Reference Manual*
“Wireless LAN”

C: Bluetooth antenna

<Only for model with Bluetooth>

→ *Reference Manual*
“Bluetooth”

D: GPS antenna

<Only for model with GPS>

Wireless WAN antenna

<Only for model with wireless WAN and without GPS>

NOTE

- This computer contains a magnet and magnetic products at the locations circled in the illustration. The battery cover also has the magnet on the back side. Avoid leaving metallic object or magnetic media in contact with these areas.

<Only for model with
1D Barcode Reader>

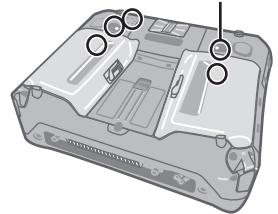

Preparation

■ Confirmation

① Check and identify the supplied accessories.

If you do not find the described accessories, contact Panasonic Technical Support (➔ page 56).

- AC Adaptor. 1
- AC Cord 1
- Battery Packs 2

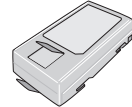
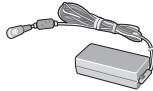

Model No: CF-AA1633A

Model No: CF-VZSU53W

- Stylus 1
- Tether 1



- Soft Cloth. 1
- Operating Instructions (This book) 1
- Product Recovery DVD-ROM Windows® 7 Professional 1

② Read the LIMITED USE LICENSE AGREEMENT before breaking the seal on the computer's packaging (➔ page 46).

■ Inserting the Battery Packs

Insert the battery pack to 2 battery cases.

Place the computer on a soft cloth with the panel side down.

- Make sure that there is no item under the computer.

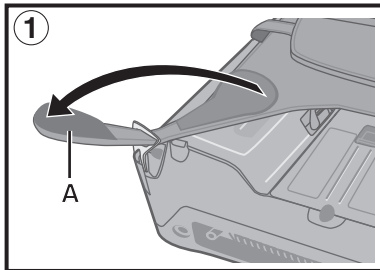

① Remove the edge (A) of hand strap passing through the clip. (The illustration shows the left side of hand strap as an example.)

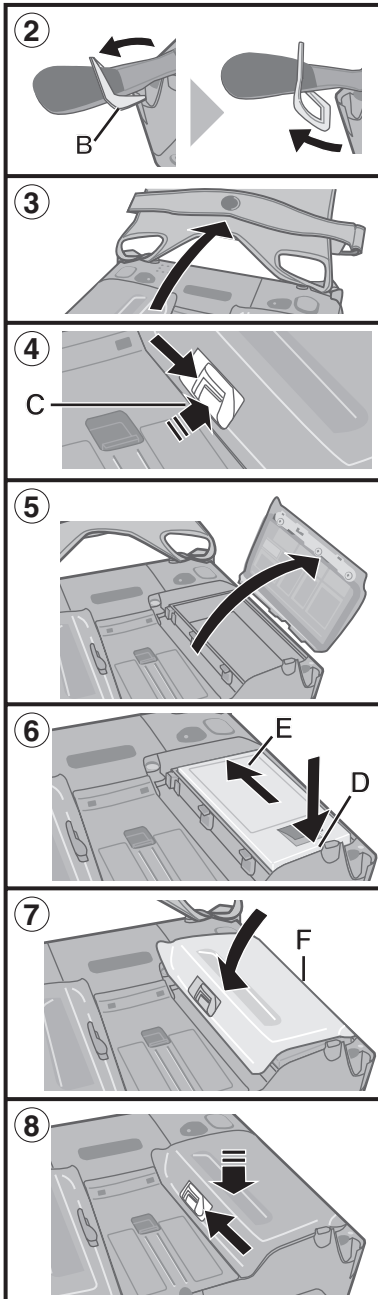

② Tip the clip (B) front to pull it out of the computer. (Do the same for the right side of hand strap.)

③ Open up the whole hand strap.

④ Press and hold (C) and slide the latch to unlock the battery cover. (The illustration shows Battery 1 as an example.)

⑤ Remove the battery cover.

⑥ Insert the battery pack matching with (D) side.

Then, slide down the battery pack (E).

⑦ Attach the battery cover.

Insert the claw (F) of the cover matching the dent of computer, and press down the latch side of cover to close.

- Make sure the latch is on the “OPEN” side.

- If the cover does not close firmly, insert the claw again. If the problem persists, check if the battery is inserted properly.

⑧ Press and hold the battery cover and slide the latch to fix.

(Take the steps ④ to ⑧ for Battery 2 as well.)

⑨ Attach the hand strap back to the original form.

Take the steps ① and ② in the reverse order.

CAUTION

- The computer does not operate without the battery cover attached.
- Make sure the latch is securely locked. Otherwise the battery pack may fall when you carry the computer.
- Do not touch the terminals of the battery pack and the computer. Doing so can make the terminals dirty or damaged, and may cause malfunction of the battery pack and the computer.

Preparation

About the battery for this computer

This computer uses 2 battery packs.

The battery is charged (→ page 25) and power is consumed only on either battery pack. Those operations switch to the other battery pack automatically.

- When the computer is connected to the Cradle (optional: CF-VEBU11U), the battery pack is charged when the AC adaptor is connected to the Cradle.
- With the battery charger (optional: CF-VCBU11U) or the Cradle (optional: CF-VEBU11U), you can remove the empty battery pack and charge it while using the computer.
- You can insert or remove the battery pack while the computer is ON. Be sure not to remove the battery pack being used by mistake. (→  *Reference Manual* “Battery Power”)

NOTE

- To conserve power, the following power saving methods are set at the time of purchase.

Windows 7

- The screen automatically turns off after 10 minutes of inactivity.
 - The computer automatically enters sleep^{*1} after 20 minutes of inactivity.
- ^{*1} →  *Reference Manual* “Sleep and Hibernation Functions” about resuming from sleep.

Windows XP

- The screen automatically turns off after 15 minutes of inactivity.
 - The computer automatically enters standby^{*2} after 20 minutes of inactivity.
- ^{*2} →  *Reference Manual* “Standby and Hibernation Functions” about resuming from standby.
- Note that the computer consumes electricity even when the computer power is off. If the battery pack is fully charged, the battery will fully discharge in the following period of time:
 - When power is off: Approx. 4 weeks
 - In sleep (**Windows 7**) / standby (**Windows XP**) : Approx. 2 days
 - In hibernation: Approx. 3 days
 - When the DC plug is not connected to the computer, disconnect the AC cord from your AC wall outlet. Power is consumed simply by having the AC adaptor plugged into an electrical outlet.

Power consumption in each mode is as follows. (When AC adaptor is connected)

 - When the screen is off: Approx. 7.4 W
 - In sleep (**Windows 7**) / standby (**Windows XP**) : Approx. 1 W
 - The battery pack is fully charged (or not being charged) and the computer is off: Approx. 0.9 W

■ Attaching the stylus to the computer

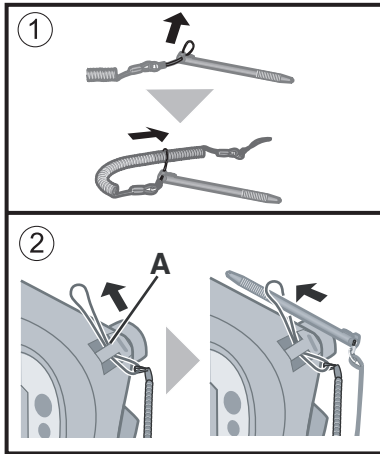

We recommend you fix the stylus in safe to the computer using the tether (supplied).

- ① Attach the tether to the stylus.
- ② Insert the tether to (A) of computer and pass the stylus to fix.

You can store the stylus at (B) or (C) of the computer.

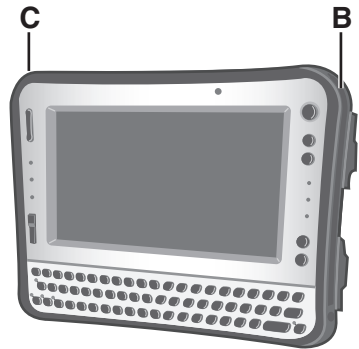

■ Using the stylus

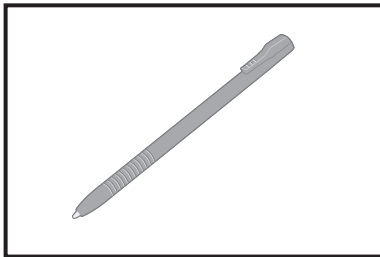

You can use the touchscreen function to perform the same operation as the mouse. Touch the screen surface with the stylus (included).

To right-click

Windows 7

Touch and hold with the stylus, or touch and select the right button of “touch pointer”.

Windows XP

- ① Click  on the notification area or on the desktop.
- ② Click the object you want to right-click.

Preparation

■ Using the hand strap

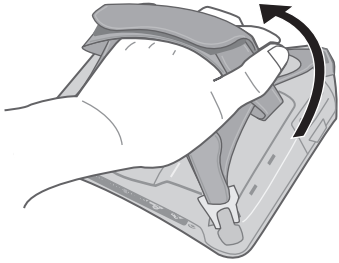
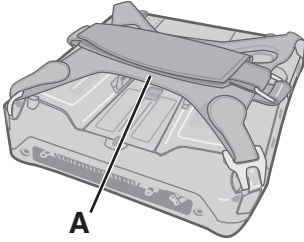

When using the computer holding with hand, insert your hand to (A) part of the hand strap. Fix the hand strap firmly so that the computer does not come off, and then turn it over.

- When the hand strap is too loose or too tight, you can adjust the hand strap according to the instructions below.

CAUTION

- If the hand is not securely fixed to the hand strap, the computer may drop.

■ Adjusting the hand strap

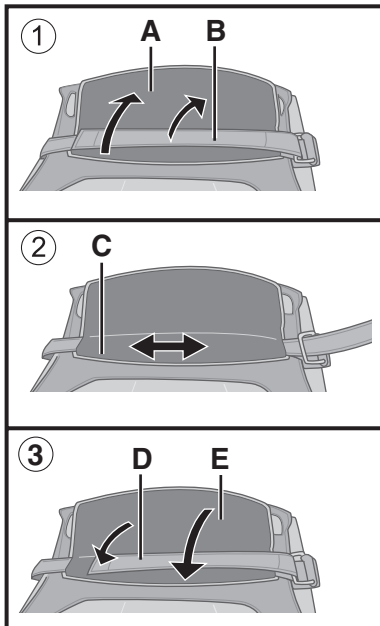

Adjust the fastening strength of hand strap as below.

- ① Remove (A) from the strap joint and next remove (B).
- ② Adjust the position (C).
- ③ Attach (D), then (E) to the joint.
Attach the hand strap firmly so that the strap does not come off.

CAUTION

- If the hand strap loosens, the computer may fall down.
- Do not use the strap if it becomes worn or damaged.

First-time Operation

■ Setting up the computer

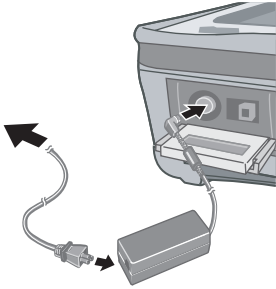

1 Connect your computer to a power outlet.

The battery charging starts automatically. (→ page 22).

CAUTION

- Do not disconnect the AC adaptor until the “Setting up the computer” procedure is completed.
- When using the computer for the first time, do not connect any peripheral device except the battery pack and AC adaptor.
- **Handling the AC adaptor**
 - Problems such as sudden voltage drops may arise during periods of thunder and lightning. Since this could adversely affect your computer, an uninterruptible power source (UPS) is highly recommended unless running from the battery pack alone.

Getting Started

2 Turn on the computer.

- ① Press the power switch (A).
The power indicator  lights.

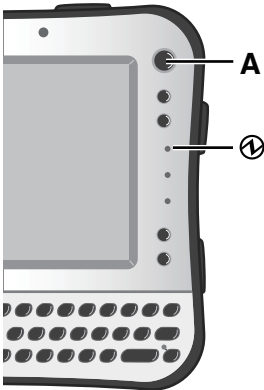

CAUTION

- Do not press the power switch repeatedly.
- The computer will forcibly be turned off if you press and hold the power switch for 4 seconds or longer.
- Once you turn off the computer, wait for 10 seconds or more before you turn on the computer again.
- Do not perform the following operation until the flash memory drive indicator  turns off.
 - Connecting or disconnecting the AC adaptor
 - Pressing the power switch
 - Touching the keyboard, touchscreen or external mouse
 - Turn on/off the wireless switch
- When the CPU temperature is high, the computer may not start up to prevent overheating of the CPU. Wait until the computer cools down, and then turn the power on again. If the computer does not power on even after cooling down, contact Panasonic Technical Support (→ page 56).
- Any changes from the default setting of the Setup Utility must not be made until the “Setting up the computer” procedure is completed.

3 Setup Windows.

During setup of Windows, use the stylus to move the cursor and to click an item. (→ page 23)

① Follow the on-screen instructions.

Windows 7

- After the computer is turned on, the screen remains black or unchanged for a while, but this is not a malfunction. Wait for a moment until the Windows setup screen appears.
- Setup of Windows will take approximately 20 minutes. Go to the next step, confirming each message on the display.

CAUTION

- You cannot choose the following words for user name and password: CON, PRN, AUX, CLOCK\$, NUL, COM1 to COM9, LPT1 to LPT9.
- Do not use an “@” mark for user name and password.

Windows 7

A password will be requested at the log-on screen, even if no password has been set. If you try to log on without entering a password, “The user name or password is incorrect.” is displayed and you will not be able to log on to Windows (→ page 37).

- You can change the user name, password, image and Wireless Networks (**Windows 7**) / security setting (**Windows XP**) after setup of Windows.
- Remember your password. If you forget the password, you cannot use the Windows. Creating a password reset disk beforehand is recommended.

Windows XP

- When you set date/time/time zone and click [Next], the screen may not go to the next step for a few minutes. Do not touch the keyboard, and wait until the screen changes.
 - If “An unexpected error has occurred...” (or a similar message) is displayed, click [OK]. This is not a malfunction.
 - Wait until the flash memory drive indicator  has turned off.
-

4 Perform the touchscreen calibration.

Windows 7

At first, log on to Windows as an administrator, and perform this calibration.

- ① Click  (Start) - [Control Panel] - [Hardware and Sound] - [Tablet PC Setting].
- ② Click [Calibrate].
- ③ Select [Touch input].
- ④ Using the stylus, touch each of the “+” target marks one by one, and then click [Yes].

Perform the following calibration for each user.

- ① Click  (Start) - [Control Panel] - [Hardware and Sound] - [Tablet PC Settings].
- ② Click [Calibrate].
- ③ Select [Touch input] or [Pen input].
- ④ Using the stylus, touch each of the “+” target marks one by one, and then click [Yes].

Windows XP

- ① Click [start] - [Control Panel] - [Other Control Panel Options] - [Touch Panel].
- ② Select [Calibration] in [Touch Panel Settings].
- ③ Select [9 point], [12 point] or [20 point] in [Accuracy required], and click [Apply].
- ④ Click [Calibrate Now] in [Calibration].
- ⑤ Using the stylus, touch each of the “+” target marks one by one until it blinks, and then press  (Enter).
- ⑥ Click [Update] in [Calibration].
- ⑦ Click [OK].

Windows XP

5 Create a new account.

- ① Click [start] - [Control Panel] - [User Accounts] - [Create a new account].

CAUTION

- Remember your password. If you forget the password, you cannot use the Windows operation system. Creating a password reset disk beforehand is recommended.

NOTE

● PC Information Viewer

This computer periodically records the management information of the flash memory, etc. The maximum data volume for each record is 2048 bytes. This information is only used for estimating the cause when the flash memory goes down by any possibility. They are never sent to outside via network nor used for any other purpose except for the purpose described the above.

To disable the function, add the check mark for [Disable the automatic save function for management information history] in [Hard Disk Status] of PC Information Viewer, and click [OK].

(→  *Reference Manual* “Checking the Computer’s Usage Status”)

■ Precaution against Starting Up/Shutting Down

- Do not do the following
 - Connecting or disconnecting the AC adaptor
 - Pressing the power switch
 - Touching the keyboard, touchscreen or external mouse
 - Turn on/off the wireless switch

Windows 7

■ To change the partition structure

You can shrink a part of an existing partition to create unallocated disk space, from which you can create a new partition. In the default setting, you can use a single partition.

- ① Click  (Start) and right-click [Computer], then click [Manage].
 - A standard user needs to enter an administrator password.
- ② Click [Disk Management].
- ③ Right-click the partition for Windows (“c” drive in the default setting), and click [Shrink Volume].
 - The partition size depends on the computer specifications.
- ④ Input the size in [Enter the amount of space to shrink in MB] and click [Shrink].
 - You cannot input a larger number than the displayed size.
 - To select [Reinstall to the first 2 partitions.] in reinstalling Windows 7 (→ page 35), 30000 MB or more is necessary for [Total size after shrink in MB].
- ⑤ Right-click [Unallocated] (the shrunk space in the step ④) and click [New Simple Volume].
- ⑥ Follow the on-screen instructions to make the settings, and click [Finish]. Wait until formatting is completed.

First-time Operation

NOTE

- You can create an additional partition using remaining unallocated space or newly creating unallocated space.
 - To delete a partition, right-click the partition and click [Delete Volume] in the step ③.
-

Windows XP

■ Flash Memory Backup/Restore

- Use the commercial software to backup the entire data on the flash memory drive.

On-screen Manual

You can access the Reference Manual and the Important Tips on the computer screen.



When you access the Reference Manual and the Important Tips for the first time, the License Agreement of the Adobe Reader may be displayed. Read it carefully and select [Accept] to proceed.

■ Reference Manual

The Reference Manual contains the practical information to help you fully enjoy the computer's performance.

To access the Reference Manual:

Windows 7

- ① Double-click  on the desktop.
 - Alternatively click  (Start) - [All Programs] - [Panasonic] - [On-Line Manuals] - [Reference Manual].

Windows XP



- ① Click [start] - [Reference Manual].

■ Important Tips

The Important Tips will provide you with the battery information so that you can use the battery pack in the optimum condition to obtain longer operation time.

To access the Important Tips:

Windows 7

- ① Double-click  on the desktop.
 - Alternatively click  (Start) - [All Programs] - [Panasonic] - [On-Line Manuals] - [Important Tips].

Windows XP

- ① Double-click  on the desktop.
 - Alternatively click [start] - [All Programs] - [Panasonic] - [Battery] - [Important Tips] or click [start] - [All Programs] - [Panasonic] - [On-Line Manuals] - [Important Tips].

NOTE

- When Adobe Reader update notice is displayed, we recommend you follow the on-screen procedure and update.
See <http://www.adobe.com/> for the latest version of Adobe Reader.

Handling and Maintenance

Operation environment

- Temperature: Operation : -10 °C to 50 °C {14 °F to 122 °F} (IEC60068-2-1, 2)^{*1}
Storage : -20°C to 60 °C {- 4 °F to 140 °F}
 - Humidity: Operation : 30% to 80% RH (No condensation)
Storage : 30% to 90% RH (No condensation)
- Even within the above temperature/humidity ranges, using for a long time in an extreme environment will result in the product deterioration and will shorten the product life.
- ^{*1} Do not expose the skin to this product when using the product in a hot or cold environment. (→ page 14)
- If the computer is wet in temperatures of 0 °C {32 °F} or below, freeze damage may occur. Make sure to dry off the computer in such temperatures.
- Do not place the computer in the following areas, otherwise the computer may be damaged.
 - Near electronic equipment. Image distortion or noise may occur.
 - In extremely high or low temperature.
 - As the computer can become hot during operation, keep it away from items that are sensitive to heat.

Handling cautions

This computer is designed to minimize shock to parts such as the LCD and the flash memory and equipped with a drip-proof keyboard, but no warranty is provided against any trouble caused by shock. Be extremely careful when handling the computer.

- When carrying the computer:
 - Turn off the computer.
 - Remove all external devices, cables and other protruding things and then close all terminal covers.
 - Do not drop or hit the computer against solid objects.
 - Do not grip the display part.
- When you board an airplane, take the computer with you and never put it in your checked luggage. When using the computer on airplane, follow the airline's instructions.
- When carrying a spare battery, put it in a plastic bag to protect its terminals.
- Be careful of computer drop resulting from the hand strap damage.
- Use only the included stylus to touch the screen. Do not place any object on its surface and do not press down strongly with sharp-pointed or hard objects that may leave marks (e.g., nails, pencils and ball point pens).
- Do not use the stylus when dust or dirt (e.g., oil) is on the screen. Otherwise foreign particles on the screen/stylus can scratch the screen surface or obstruct the stylus operation.
- Use the stylus only for touching the screen. Using it for any other purpose may damage the stylus and result in scratches on the screen.

■ When using peripheral devices

Follow these instructions and the Reference Manual to avoid any damage to the devices. Carefully read the instruction manuals of the peripheral devices.

- Use the peripheral devices conforming to the computer's specifications.
- Connect to the connectors in the correct direction.
- If it is hard to insert, do not try forcibly but check the connector's shape, direction, alignment of pins, etc.
- If screws are included, fasten them securely.
- Remove the cables when you carry the computer. Do not pull the cables forcibly.

■ Preventing your computer from unauthorized use via wireless LAN/Bluetooth/Wireless WAN

<Only for model with wireless LAN/Bluetooth/Wireless WAN>

- Before using wireless LAN/Bluetooth/Wireless WAN, make the appropriate security settings such as data encryption.

■ Computrace® Software

Computrace® software tracks your stolen computer.

- Computrace® software is not included or installed in this computer.
- Consult Absolute Software Corp. before disposal.
- Refer to the following URL for Computrace® software for installation and available service regions. Note that this service is only available in certain regions.
<http://www.absolute.com>

Maintenance

To clean the LCD panel

Use the soft cloth included with the computer. (For further information, refer to "Suggestions About Cleaning the LCD Surface" that comes with the soft cloth.)

To clean areas other than the LCD panel

Wipe with a soft dry cloth such as gauze. When using detergent, dip a soft cloth in water-diluted detergent and wring it thoroughly.

CAUTION

- Do not use benzene, thinner, or rubbing alcohol since it may adversely affect the surface causing discoloration, etc. Do not use commercially-available household cleaners and cosmetics, as they may contain components harmful to the surface.
- Do not apply water or detergent directly to the computer, since liquid may enter inside of the computer and cause malfunction or damage.

Reinstalling Software

Reinstalling software will return the computer to the default condition. When you reinstall the software, the flash memory data will be erased.

Back up important data to other media or an external hard disk before reinstallation.

Preparation

- Prepare the following items:
 - The Product Recovery DVD-ROM (included)
 - USB DVD drive (optional) (refer to recent catalogs and other sources for information about the products available)
- Remove all peripherals (except for the DVD drive).
- Connect the AC adaptor and do not remove it until reinstallation is complete.

- 1 Turn off the computer and connect the DVD drive to the USB port (→ page 18).**
- 2 Turn on the computer, and press $\overline{\text{Fn}} + \overline{\text{U}}$ (F2) or $\overline{\text{Fn}} + \overline{\leftarrow}$ (Del) while [Panasonic] boot screen is displayed.**
The Setup Utility starts up.
 - If the password is requested, enter the Supervisor Password.
- 3 Write down all of the contents of the Setup Utility and press $\overline{\text{Fn}} + \overline{\square}$ (F9).**
At the confirmation message, select [Yes] and press $\overline{\downarrow}$ (Enter).
- 4 Press $\overline{\text{Fn}} + \overline{\text{B}}$ (F10).**
At the confirmation message, select [Yes] and press $\overline{\downarrow}$ (Enter).
The computer will restart.
- 5 Press $\overline{\text{Fn}} + \overline{\text{U}}$ (F2) or $\overline{\text{Fn}} + \overline{\leftarrow}$ (Del) while [Panasonic] boot screen is displayed.**
The Setup Utility starts up.
 - If the password is requested, enter the Supervisor Password.
- 6 Set the Product Recovery DVD-ROM into the DVD drive.**
- 7 Select the [Exit] menu, then select your DVD drive in [Boot Override].**
- 8 Press $\overline{\downarrow}$ (Enter).**
The computer will restart.

- 9 Click [Reinstall Windows] and click [Next].**

The License Agreement screen appears.
- 10 Click [Yes, I agree to the provisions above and wish to continue!] and click [Next].**
- 11 Select the settings and click [Next].**
 - [Reinstall Windows to the whole Hard Disk to factory default.]
Select this option when you want to reinstall Windows to the factory default. After reinstallation, you can create a new partition. For how to create a new partition, refer to “To change the partition structure” (→ page 29).
 - [Reinstall to the first 2 partitions.]*¹
Select this option when the flash memory has already been divided into several partitions. For how to create a new partition, refer to “To change the partition structure” (→ page 29).
You can keep the partition structure.
¹ This does not appear if Windows cannot be reinstalled to the recovery partition and the area usable by Windows.
- 12 At the confirmation message, click [YES].**

Reinstallation starts according to the instructions on the screen. (It will take approximately 50 minutes.)

 - Do not interrupt reinstallation, for example by turning off the computer or pressing **Ctrl**, **Alt** and **Fn** + **←** (Del). Otherwise reinstallation may become unavailable as Windows may not start up or the data may be corrupted.
- 13 Remove the Product Recovery DVD-ROM, and then click [OK] to turn off the computer, then remove the DVD drive.**
- 14 Turn on the computer.**
 - If the password is requested, enter the Supervisor Password.
- 15 Perform the steps 3 to 5 for setting up the computer (→ pages 26 and 29).**
- 16 Start the Setup Utility to change the settings as necessary.**
- 17 Perform Windows Update.**

Troubleshooting (Basic)

Follow the instructions below when a problem has occurred. There is also an advanced troubleshooting guide in the “Reference Manual”. For a software problem, refer to the software’s instruction manual. If the problem persists, contact Panasonic Technical Support (→ page 56). You can also check the computer’s status in the PC Information Viewer

(→  *Reference Manual* “Checking the Computer’s Usage Status”).

■ Starting Up

<p>Cannot start up. The power indicator or battery indicator is not lit.</p>	<ul style="list-style-type: none">● Connect the AC adaptor.● Insert a fully charged battery.● Remove the battery pack and the AC adaptor, then connect them again.● If a device is connected to the USB port, disconnect the device, or set [Legacy USB Support] to [Disabled] in the [Advanced] menu of the Setup Utility. (→  <i>Reference Manual</i> “Setup Utility”)
<p>The power is turned on but “Warming up the system (up to 30 minutes)” appears.</p>	<ul style="list-style-type: none">● The computer is warming up before start up. Wait for the computer to start up (takes up to 30 minutes). If, “Cannot warm up the system” is displayed, the computer failed to warm up and does not start. In this case, turn off the computer, leave it in an environment of 5 °C {41 °F} or higher temperature for about an hour, and then turn on the power again.
<p>Cannot turn on the computer. The computer does not resume from sleep (Windows 7) / standby (Windows XP). (The power indicator blinks quickly in green.)</p>	<ul style="list-style-type: none">● Leave it in an environment of 5 °C {41 °F} or higher temperature for about an hour, then turn on the power again.



■ Starting Up

<p>You have forgotten the password.</p>	<ul style="list-style-type: none"> ● Supervisor Password or User Password: Contact Panasonic Technical Support (→ page 56). ● Administrator password: <ul style="list-style-type: none"> • If you have a password reset disk, you can reset the administrator password. Set the disk and enter any wrong password, then follow the on-screen instructions and set a new password. • If you do not have a password reset disk, reinstall (→ page 34) and set up Windows, and then set a new password.
<p>Windows 7 Cannot log on to Windows. (“The user name or password is incorrect” is displayed.)</p>	<ul style="list-style-type: none"> ● The user name (account name) includes an “@”. <ul style="list-style-type: none"> • If another user account exists: Log on to Windows using another user account, and delete the account that includes “@”. Then create a new account. • If no other account name exists: You need to reinstall Windows (→ page 34).
<p>“Remove disks or other media. Press any key to restart” or a similar message appears.</p>	<ul style="list-style-type: none"> ● A floppy disk is in the drive and it does not contain system startup information. Remove the floppy disk and press any key. ● If a device is connected to the USB port, disconnect the device, or set [Legacy USB Support] to [Disabled] in the [Advanced] menu of the Setup Utility. (→  <i>Reference Manual</i> “Setup Utility”) ● If the problem persists after having tried the above solutions, it may be a flash memory failure. Contact Panasonic Technical Support (→ page 56).

Troubleshooting (Basic)

■ Starting Up

Windows startup and operation is slow.

- Press **Fn** + **F9** (F9) in the Setup Utility (→  *Reference Manual* “Setup Utility”) to return the Setup Utility settings (excluding the passwords) to the default values. Start the Setup Utility and make the settings again. (Note that the processing speed depends on the application software, so this procedure may not make Windows faster.)
- Due to the overall performance capabilities of this computer, application startup and other operations may take longer to complete when compared to other computers.
Examples:
Applications do not start up immediately after Windows startup.
Applications do not finish installing.
The operation will complete in a few moments, so please wait until the flash memory drive indicator turns off. Be aware that the cursor will not always change from the arrow icon () to an hourglass icon () while you are waiting.
- If you installed a resident software after purchase, turn off the residence.



Windows 7

- Disable the pop-up menu and Input Panel Tab.
 - ① Open the Input Panel, and click [Tools] - [Options] - [Opening].
 - ② Remove the check mark of [Show Input Panel sliding open from the tab] and click [OK].

Windows XP



- Disable Indexing Service in the following menu. Click [start] - [Search] - [Change preferences] - [With Indexing Service (for faster local service)].

■ Starting Up

<p>The date and time are incorrect.</p>	<ul style="list-style-type: none"> ● Make the correct settings. <ul style="list-style-type: none"> Windows 7 Click  (Start) - [Control Panel] - [Clock, Language, and Region] - [Date and Time]. Windows XP Click [start] - [Control Panel] - [Date, Time, Language, and Regional Options] - [Date and Time]. ● If the problem persists, the internal clock battery may need to be replaced. Contact Panasonic Technical Support (→ page 56). ● When the computer is connected to LAN, check the date and time of the server. ● The 2100 A.D. or later year will not be correctly recognized on this computer.
<p>[Executing Battery Recalibration] screen appears.</p>	<ul style="list-style-type: none"> ● The Battery Recalibration was canceled before Windows was shut down last time. To start up Windows, turn off the computer by the power switch, and then turn on.
<p>[Enter Password] does not appear when resuming from (Windows 7) sleep / (Windows XP) standby or hibernation.</p>	<ul style="list-style-type: none"> Windows 7 <ul style="list-style-type: none"> ● The password you have set in the Setup Utility is not requested at resuming. To use the password security at resuming, set the Windows password. <ol style="list-style-type: none"> ① Click  (Start) - [Control Panel] - [User Accounts and Family Safety] - [Add or remove user accounts] and select the account, and set the password. ② Click  (Start) - [Control Panel] - [System and Security] - [Power Option] - [Require a password when the computer wakes] and add a check mark for [Require a password]. Windows XP <ul style="list-style-type: none"> ● Set the Windows password. The password you have set in the Setup Utility is not requested at resuming. <ol style="list-style-type: none"> ① Click [start] - [Control Panel] - [User Accounts] and select the account, and set the password. ② Click [start] - [Control Panel] - [Performance and Maintenance] - [Power Options] - [Advanced] and add a check mark for [Prompt for password when computer resumes from standby].

Troubleshooting (Basic)

■ Starting Up

<p>Cannot resume.</p>	<ul style="list-style-type: none"> ● An error may occur when the computer automatically enters the (Windows 7) sleep / (Windows XP) standby or hibernation mode while the screensaver is active. In this case, turn off the screensaver or change the pattern of the screensaver. ● If you press and hold the power switch for 4 seconds or longer, the power will be turned off forcibly and the computer will not resume. In this case, all unsaved data will be lost. ● You disconnected the AC adaptor and the battery pack while the computer was in (Windows 7) sleep / (Windows XP) standby. If the computer's power supply is disconnected in (Windows 7) sleep / (Windows XP) standby, unsaved data will be lost and the computer will not resume. ● The battery is exhausted. (Windows 7) sleep / (Windows XP) standby and hibernation consume some power.
<p>Other startup problems.</p>	<ul style="list-style-type: none"> ● Press F\overline{n} + $\overline{\square}$ (F9) in the Setup Utility (→  <i>Reference Manual</i> "Setup Utility") to return the Setup Utility settings (excluding the passwords) to the default values. Start the Setup Utility and make the settings again. ● Remove all peripheral devices. ● Check to see if there was a disk error. <ul style="list-style-type: none"> Windows 7 <ol style="list-style-type: none"> ① Remove all peripheral devices including an external display. ② Click  (Start) - [Computer] and right-click [Local Disk (C:)], and click [Properties]. ③ Click [Tools] - [Check Now]. <ul style="list-style-type: none"> • A standard user needs to enter an administrator password. ④ Select the option in [Check disk options] and click [Start]. ⑤ Click [Schedule disk check] and restart the computer. Windows XP <ol style="list-style-type: none"> ① Click [start] - [My Computer] and right-click [Local Disk(C:)], and click [Properties]. ② Click [Tools] - [Check Now]. ③ Select the option in [Check disk options] and click [Start]. ● Start the computer in Safe Mode and check the error details. When the [Panasonic] boot screen disappears*¹ at startup, press and hold F\overline{n} + \overline{L} (F8) until the Windows Advanced Options Menu is displayed. Select the Safe Mode and press $\overline{\leftarrow}$ (Enter). <p>^{*1} When [Password on boot] is set to [Enabled] in the [Security] menu of the Setup Utility, [Enter Password] appears after the [Panasonic] boot screen disappears. As soon as you enter the password and press $\overline{\leftarrow}$ (Enter), press and hold F\overline{n} + \overline{L} (F8).</p>

■ Shutting down

Windows does not shut down.	<ul style="list-style-type: none"> ● Remove the USB device. ● Wait one or two minutes. It is not a malfunction.
-----------------------------	---

■ Display

No display.	<ul style="list-style-type: none"> ● The external display is selected. Press Fn + E (□/□) to switch the display. Wait until the display has been switched completely before pressing Fn + E (□/□) again. ● When using an external display, <ul style="list-style-type: none"> • Check the cable connection. • Turn on the display. • Check the settings of external display. ● The display is turned off by the power-saving function. To resume, do not press the direct selection keys, but press any other key like Ctrl. ● The computer entered (Windows 7) sleep / (Windows XP) standby or hibernation by the power-saving function. To resume, press the power switch. <p>Windows XP</p> <ul style="list-style-type: none"> ● The screen may not be displayed even after the computer resumed from standby or hibernation. In this case, press Fn + I (⌘) to enter standby and resume the computer again.
The screen is dark.	<ul style="list-style-type: none"> ● The screen is darker when the AC adaptor is not connected. Press Fn + W (☀▲) and adjust the brightness. As you increase the brightness, battery consumption increases. You can separately set the brightness for when the AC adaptor is connected and when not connected.
<p>Windows XP</p> The LCD brightness changes a number of times when the AC adaptor is disconnected.	<ul style="list-style-type: none"> ● Intel(R) Display Power Saving Technology is active and automatically changes the LCD brightness. This is not a malfunction.

Troubleshooting (Basic)

■ Display

The screen is disordered.	<ul style="list-style-type: none">● Changing the number of display colors and resolution may affect the screen. Restart the computer.● Connecting/disconnecting an external display may affect the screen. Restart the computer.
Motion picture becomes disordered.	<ul style="list-style-type: none">● If you use the zoom function when playing motion picture, motion picture may become disordered. Disable the zoom function.
During Simultaneous display, one of the screens becomes disordered.	<ul style="list-style-type: none">● Simultaneous display cannot be used until Windows startup is complete (during Setup Utility, etc.). <p>Windows 7</p> <ul style="list-style-type: none">● When using the Extended Desktop, use the same display colors for the external display as those used by the LCD.● If you continue to experience problems, try changing the display. Right-click on the desktop, and click [Graphics Properties] - [Display Devices]. <p>Windows XP</p> <ul style="list-style-type: none">● If the [Command Prompt] is displayed in full-screen, reduce the display size.
The external display does not work normally.	<ul style="list-style-type: none">● If the external display does not support the power saving function, it may not work normally when the computer enters the power saving mode. Turn off the external display.
<p>Windows 7</p> When the computer starts up, simultaneous display becomes active.	<ul style="list-style-type: none">● When simultaneous display is activated, press Fn + E (□/□) to switch the display.

■ Display

<p>Windows 7 <Only for model with GPS> The cursor cannot be controlled properly.</p>	<ul style="list-style-type: none"> ● Operate the following steps. <ol style="list-style-type: none"> ① Set [GPS] to [Disabled] in the [Advanced - Serial Port Configuration] of the Setup Utility. ② Press Fn + B (F10) and select [Yes] at the confirmation message, and press ↵ (Enter). The computer will restart. ③ Log on to Windows as an administrator. ④ Click ⊕ (Start) and input "c:\util\drivers\gps\GPS.reg" in [Search programs and files], and press ↵ (Enter). ⑤ Click [Yes], click [Yes] and click [OK]. Then Restart the Computer. ⑥ Press Fn + U (F2) while [Panasonic] boot screen is displayed. ⑦ Set [GPS] to [Enabled] in the [Advanced - Serial Port Configuration]. ⑧ Press Fn + B (F10) and select [Yes] at the confirmation message, and press ↵ (Enter).
<p>The cursor can not be displayed at the right position.</p>	<ul style="list-style-type: none"> ● When using application software displaying a unique cursor (i.e. Paint), note the following restrictions. <ul style="list-style-type: none"> • The cursor unique for the application software is not enlarged. • The cursor unique for the application software may not be displayed at the right position. Confirm the operation position using the Windows cursor (enlarged cursor when zoomed).

■ Touchscreen

<p>The cursor does not work.</p>	<ul style="list-style-type: none"> ● When using the external mouse, connect it correctly. ● Restart the computer using the keyboard. <p>Windows 7 Press ⊕ (Windows) and press → two times, and press ↑ to select [Restart] and press ↵ (Enter).</p> <p>Windows XP Press ⊕ (Windows), U and R to select [Restart].</p> ● If the computer does not respond to keyboard commands, read "No response." (→ page 45).
<p>Cannot input using the touchscreen.</p>	<ul style="list-style-type: none"> ● Set [Touchscreen Mode] to [Auto] or [Tablet] in the [Main] menu of the Setup Utility.

Troubleshooting (Basic)



■ Touchscreen

Cannot point the correct position using the included stylus.

- Perform the touchscreen calibration (→ page 28).

■ Reference Manual



The Reference Manual is not displayed.

- Install Adobe Reader.
 - ① Log on to Windows as an administrator.
 - ② **Windows 7**
Click  (Start) and input "c:\util\reader\setup.exe" in [Search programs and files] then press  (Enter).
Windows XP
Click [start] - [Run], input "c:\util\reader\setup.exe", then click [OK].
Follow the on-screen instructions.
 - ③ Update Adobe Reader to its latest version.
If your computer is connected to the internet, start up Adobe Reader and click [Help] - [Check for Updates].

Cannot close full screen mode of Adobe Reader.

- Click [Edit] - [Preferences] - [Full Screen] and add the check mark to [Show navigation bar] before starting full screen mode.
- If you started full screen mode without above setting, set the computer to the Cradle and connect the external keyboard to the Cradle, then press **Tab** (Esc).

■ Others

No response.	<ul style="list-style-type: none">● Press Ctrl, ⇧ (Shift), Fn and Tab (Esc) to open Task Manager and close the software application that is not responding.● An input screen (e.g., password input screen at startup) may be hidden behind another window. Press Alt + Tab to check.● Press the power switch for 4 seconds or longer to shut down the computer, and then press the power switch to turn it on. If the application program does not work normally, uninstall and reinstall the program. To uninstall: Windows 7 Click  (Start) - [Control Panel] - [Uninstall a program]. Windows XP Click [start] - [Control Panel] - [Add or Remove Programs].
To erase flash memory data	<p>Windows 7 (→  <i>Reference Manual</i> “Flash Memory Data Erase Utility” page 100)</p> <p>Windows XP (→  <i>Reference Manual</i> “Flash Memory Data Erase Utility” page 98)</p> <p>For step 9 to 14, perform the procedures below.</p> <div style="border: 1px solid black; padding: 5px;"><p>9 Click [Erase the whole data on the Hard Disk for security] and click [Next].</p><p>10 At the confirmation message, click [YES].</p><p>11 Click [Continue].</p><p>12 Click [Continue] again.</p><p>13 Click [YES].</p><p>Erasing the flash memory data starts.</p><p>14 After erasing is completed, remove the Product Recovery DVD-ROM and click [OK].</p></div>

LIMITED USE LICENSE AGREEMENT

THE SOFTWARE PROGRAM(S) (“PROGRAMS”) FURNISHED WITH THIS PANASONIC PRODUCT (“PRODUCT”) ARE LICENSED ONLY TO THE END-USER (“YOU”), AND MAY BE USED BY YOU ONLY IN ACCORDANCE WITH THE LICENSE TERMS DESCRIBED BELOW. YOUR USE OF THE PROGRAMS SHALL BE CONCLUSIVELY DEEMED TO CONSTITUTE YOUR ACCEPTANCE OF THE TERMS OF THIS LICENSE.

Panasonic Corporation has developed or otherwise obtained the Programs and hereby licenses their use to you. You assume sole responsibility for the selection of the Product (including the associated Programs) to achieve your intended results, and for the installation, use and results obtained therefrom.

LICENSE

- A. Panasonic Corporation hereby grants you a personal, non-transferable and non-exclusive right and license to use the Programs in accordance with the terms and conditions stated in this Agreement. You acknowledge that you are receiving only a LIMITED LICENSE TO USE the Programs and related documentation and that you shall obtain no title, ownership nor any other rights in or to the Programs and related documentation nor in or to the algorithms, concepts, designs and ideas represented by or incorporated in the Programs and related documentation, all of which title, ownership and rights shall remain with Panasonic Corporation or its suppliers.
- B. You may use the Programs only on the single Product which was accompanied by the Programs.
- C. You and your employees and agents are required to protect the confidentiality of the Programs. You may not distribute or otherwise make the Programs or related documentation available to any third party, by time-sharing or otherwise, without the prior written consent of Panasonic Corporation.
- D. You may not copy or reproduce, or permit to be copied or reproduced, the Programs or related documentation for any purpose, except that you may make one (1) copy of the Programs for backup purposes only in support of your use of the Programs on the single Product which was accompanied by the Programs. You shall not modify, or attempt to modify, the Programs.
- E. You may transfer the Programs and license them to another party only in connection with your transfer of the single Product which was accompanied by the Programs to such other party. At the time of such a transfer, you must also transfer all copies, whether in printed or machine readable form, of every Program, and the related documentation, to the same party or destroy any such copies not so transferred.
- F. You may not remove any copyright, trademark or other notice or product identification from the Programs and you must reproduce and include any such notice or product identification on any copy of any Program.

YOU MAY NOT REVERSE ASSEMBLE, REVERSE COMPILE, OR MECHANICALLY OR ELECTRONICALLY TRACE THE PROGRAMS, OR ANY COPY THEREOF, IN WHOLE OR IN PART.

YOU MAY NOT USE, COPY, MODIFY, ALTER, OR TRANSFER THE PROGRAMS OR ANY COPY THEREOF, IN WHOLE OR IN PART, EXCEPT AS EXPRESSLY PROVIDED IN THE LICENSE.

IF YOU TRANSFER POSSESSION OF ANY COPY OF ANY PROGRAM TO ANOTHER PARTY, EXCEPT AS PERMITTED IN PARAGRAPH E ABOVE, YOUR LICENSE IS AUTOMATICALLY TERMINATED.

TERM

This license is effective only for so long as you own or lease the Product, unless earlier terminated. You may terminate this license at any time by destroying, at your expense, the Programs and related documentation together with all copies thereof in any form. This license will also terminate effective immediately upon occurrence of the conditions thereof set forth elsewhere in this Agreement, or if you fail to comply with any term or condition contained herein. Upon any such termination, you agree to destroy, at your expense, the Programs and related documentation together with all copies thereof in any form.

YOU ACKNOWLEDGE THAT YOU HAVE READ THIS AGREEMENT, UNDERSTAND IT AND AGREE TO BE BOUND BY ITS TERMS AND CONDITIONS. YOU FURTHER AGREE THAT IT IS THE COMPLETE AND EXCLUSIVE STATEMENT OF THE AGREEMENT BETWEEN US, WHICH SUPERSEDES ANY PROPOSAL OR PRIOR AGREEMENT, ORAL OR WRITTEN, AND ANY OTHER COMMUNICATIONS BETWEEN US, RELATING TO THE SUBJECT MATTER OF THIS AGREEMENT.

GOVERNMENT RESTRICTED RIGHTS.

The Software is provided with "RESTRICTED RIGHTS." Use duplication or disclosure by the government is subject to restrictions as set forth in FAR52.227-14 and DFAR252. 227-7013 et seq. or their successors.

Use of the Software by the government constitutes acknowledgement of Intel's proprietary rights therein.

Contractor or Manufacturer is Intel Corporation, 2200 Mission College Blvd., Santa Clara, CA 95052.

U.S. GOVERNMENT RESTRICTED RIGHTS:

The software and documentation are "commercial items" as that term is defined at 48 C.F.R. 2.101, consisting of "commercial computer software" and "commercial computer software documentation" as such terms are used in 48 C.F.R. 12.212 Consistent with 48 C.F.R. 12.212 and 48 C.F.R. 227.7202-1 through 227.7202-4, all U.S. Government and users acquire the software and documentation with only those rights set forth herein.

Manufacturer is identified in the copyright statement on the software.

Contrat de licence d'usage limité

Le(s) logiciel(s) (les “Logiciels”) fournis avec ce produit Panasonic (le “Produit”) sont exclusivement concédés en licence à l'utilisateur ultime (“vous”), et ils ne peuvent être utilisés que conformément aux clauses contractuelles cidessous. En utilisant les logiciels, vous vous engagez de manière définitive à respecter les termes, clauses et conditions des présentes.

Panasonic Corporation a mis au point ou obtenu les Logiciels et vous en concède l'utilisation par les présentes. Vous assumez l'entière responsabilité du choix de ce Produit (y compris des Logiciels associés) pour obtenir les résultats escomptés, ainsi que de l'installation, de l'utilisation et des résultats obtenus.

Licence

- A. Panasonic Corporation vous octroie par les présentes le droit et la licence personnels, non cessibles et non exclusifs d'utiliser les Logiciels conformément aux termes, clauses et conditions de ce contrat. Vous reconnaissez ne recevoir qu'un droit limité d'utiliser les Logiciels et la documentation les accompagnant et vous vous engagez à n'obtenir aucun droit de titre, propriété ni aucun autre droit vis-à-vis des Logiciels et de la documentation les accompagnant ni vis-à-vis des algorithmes, concepts, dessins, configurations et idées représentés par ou incorporés dans les Logiciels et la documentation les accompagnant, dont les titres, propriété et droits resteront tous à Panasonic Corporation ou à leurs propriétaires.
- B. Vous ne pouvez utiliser les Logiciels que sur le Produit unique qui est accompagné par les Logiciels.
- C. Vous et vos employés ou agents êtes requis de protéger la confidentialité des Logiciels. Vous ne pouvez ni distribuer ni mettre les Logiciels et la documentation les accompagnant à la disposition d'un tiers, par partage de temps ou de quelque autre manière que ce soit, sans l'autorisation écrite préalable de Panasonic Corporation.
- D. Vous ne pouvez ni copier ni reproduire ni permettre la copie ni la reproduction des Logiciels ni de la documentation les accompagnant pour quelque fin que ce soit, à l'exception d'une (1) copie des Logiciels à des fins de sauvegarde uniquement pour soutenir votre utilisation des Logiciels sur le Produit unique qui est accompagné par les Logiciels. Vous ne pouvez ni modifier ni tenter de modifier les Logiciels.
- E. Vous ne pouvez céder les Logiciels et en octroyer la licence à une autre partie qu'en rapport avec votre cession du Produit unique qui est accompagné par les Logiciels à cette autre partie. Au moment de cette cession, vous devez céder également toutes les copies, que ce soit sous forme imprimée ou lisible par la machine, de tous les Logiciels ainsi que de la documentation les accompagnant, à la même partie ou détruire les copies non cédées.

F. Vous ne pouvez retirer aucune marque de droits d'auteur, marque de commerce ou autre ni aucune identification de produit des Logiciels et vous devez reproduire et inclure toutes ces notices ou identifications de produit sur toutes les copies des Logiciels.

Vous ne pouvez assembler en sens inverse, compiler en sens inverse ni retracer les Logiciels ni aucune de leurs copies, de façon électronique ou mécanique, en tout ou en partie.

Vous ne pouvez utiliser, copier, modifier, altérer ni céder les Logiciels ni aucune de leurs copies, en tout ou en partie, à l'exception de ce qui est expressément stipulé dans ce contrat.

Si vous cédez la possession de toute copie ou de tout Logiciel à une autre partie, à l'exception de ce qui est autorisé au paragraphe E ci-dessus, votre licence est automatiquement résiliée.

Termes, clauses et conditions

Cette licence n'est effective que pour la durée de possession ou de crédit-bail du Produit, à moins d'une résiliation antérieure. Vous pouvez résilier cette licence à tout moment en détruisant, à vos frais, les Logiciels et la documentation les accompagnant avec toutes leurs copies, sous quelque forme que ce soit. Cette licence sera également résiliée, avec application immédiate, si les conditions de résiliation définies ailleurs dans ce contrat se sont réalisées ou si vous ne respectez pas les termes, clauses et conditions qui y sont contenues. Au moment de la résiliation, vous acceptez de détruire, à vos frais, les Logiciels et la documentation les accompagnant avec toutes leurs copies, sous quelque forme que ce soit.

Vous reconnaissez avoir lu ce contrat, en avoir compris toute la substance et avoir accepté de respecter ses termes, clauses et conditions. Vous reconnaissez en outre qu'ils sont la description complète et exclusive du contrat conclu entre nous, contrat qui remplace et annule toute proposition ou contrat précédent, écrit ou oral, et toute autre communication entre nous, relativement à l'objet du présent contrat.

Specifications

This page provides the specifications for the basic model.

The model number is different according to the unit configuration.

- To check the model number:
Check the bottom of the computer or the box the computer came in at the time of purchase.
- To check CPU speed, memory size and the flash memory drive (HDD) size:
Run the Setup Utility (→  *Reference Manual* “Setup Utility”) and select [Information] menu.
[Processor Speed]: CPU speed, [Memory Size]: Memory size, [Hard Disk]:
Flash memory drive size

■ Main Specifications

Model No.	CF-U1QQHXZDM
CPU/ Secondary cache memory	Intel® Atom™ Processor Z530 (1.60 GHz, 512 KB ^{*1} cache, 533 MHz FSB)
Chipset	Intel® System Controller Hub
Main Memory	2 GB ^{*1} DDR2 SDRAM (2 GB ^{*1} Max.)
Video Memory	256 MB ^{*1} Max. ^{*2}
Flash Memory Drive	64 GB ^{*3}
Display Method	5.6 WSVGA type (TFT) (1024 × 600 dots) 65,536/16,777,216 colors (800 × 600 dots/1024 × 600 dots/1024 × 768 dots ^{*4}) ^{*5}
Wireless LAN ^{*6}	IEEE802.11abgn Wireless LAN (→ page 52 “Wireless LAN”)
Bluetooth™ ^{*7}	(→ page 52 “Bluetooth™”)
GPS ^{*8}	Chip: SiRF starIII Accuracy: 10 m (2DRMS) <5 m (2DRMS, SBAS) Protocol message: GGA, GSA, GSV, RMC, VTG
Wireless WAN ^{*9}	Sierra™ Wireless High-speed module
Sound	WAVE and MIDI playback, Monaural speaker, Intel® High Definition Audio subsystem support
Security Chip	TPM (TCG V1.2 compliant) ^{*10}
Card Slot	SD Memory Card Slot ^{*11} x 1
Interface	USB port (4-pin, USB 2.0) ^{*12} x 1, Microphone Jack (Miniature jack, 3.5 DIA, Stereo), Headphone Jack (Miniature jack, 3.5 DIA, Impedance 32 Ω, Output Power 4 mW x 2, Stereo), Expansion Bus Connector (Dedicated 19-pin female)
Keyboard / Pointing Device	61 keys English Mini Qwerty Keyboard / Touchscreen
Fingerprint Reader ^{*13}	Array Size: 248 x 4 pixels, Image Size: 248 x 360 pixels, Image Resolution: 508 DPI

■ Main Specifications

Button	Scroll (up/down), Zoom (up/down) Application× 4	
Power Supply	AC adaptor or Battery pack	
AC Adaptor ^{*14}	Input: 100 V to 240 V AC, 50 Hz/60 Hz, Output: 16.0 V DC, 3.75 A	
Battery Pack	Li-ion 7.2 V, 2.9 Ah (typ.) / 2.7 Ah (min) × 2 packs	
Operating Time ^{*15}	Windows 7 Approx. 9 hours	
Charging Time ^{*16}	Power on	Approx. 5.5 hours
	Power off	Approx. 5.5 hours
Power Consumption ^{*17}	Approx. 15 W ^{*18} / Approx. 30 W (Maximum when recharging in the ON state)	
Physical Dimensions (W × D × H) (excluding the hand strap)	184 mm × 151 mm × 57 mm {7.24" × 5.94" × 2.24"}	
Weight (including the hand strap)	Approx. 1.06 kg {Approx. 2.34 lb.}	
Operation Environment	Temperature: -10 °C to 50 °C {14 °F to 122 °F} (IEC60068-2-1, 2) ^{*19} Humidity: 30% to 80% RH (No condensation)	
Storage Environment	Temperature: -20 °C to 60 °C {-4 °F to 140 °F} Humidity: 30% to 90% RH (No condensation)	

■ Software

Base OS	Genuine Windows® 7 Professional Service Pack 1
Installed OS ^{*20}	Windows 7 Genuine Windows® 7 Professional Service Pack 1 Windows XP Genuine Microsoft® Windows® XP Professional Service Pack 3 ^{*21}
Pre-installed Software ^{*20}	Adobe Reader, PC Information Viewer, Full Screen Zoom, Keyboard Button Manager, Bluetooth™ Stack for Windows® by TOSHIBA, Wireless Switch Utility, Hotkey Settings, Battery Recalibration Utility, Aptio Setup Utility, PC-Diagnostic Utility, Infineon TPM Professional Package ^{*10 *22} , 1D/2D Barcode Key Emulator, Camera Utility, Camera Light Switch Utility, Display Output Switcher, Panasonic Hand Writing, Right Click Utility, Software Keyboard, Sticky Key Notification, Protector Suite QL ^{*13 *22}
	Windows 7 Hard Disk Data Erase Utility ^{*23} Windows XP CPU Idle Setting, Icon Enlarger, Atheros Client Utility

Specifications

■ Wireless LAN <Only for model with wireless LAN>

Data Transfer Rates	IEEE802.11a: 54/48/36/24/18/12/9/6 Mbps ^{*24} IEEE802.11b: 11/5.5/2/1 Mbps ^{*24} IEEE802.11g: 54/48/36/24/18/12/9/6 Mbps ^{*24} IEEE802.11n: (HT20) GI=400ns: 150/130/115/86/57/43/28/14/72/65/57/ 43/28/21/14/7 Mbps ^{*24} GI=800ns: 130/117/104/78/52/39/26/13/65/58/52/ 39/26/19/13/6 Mbps ^{*24} (HT40) GI=400ns: 300/270/240/180/120/90/60/30/150/ 135/120/90/60/45/30/15 Mbps ^{*24} GI=800ns: 270/243/216/162/108/81/54/27/135/ 121/108/81/54/40/27/13 Mbps ^{*24}
Standards Supported	IEEE802.11a/IEEE802.11b/IEEE802.11g/IEEE802.11n
Transmission method	OFDM system, DS-SS system
Wireless Channels Used	IEEE802.11a: Channels 36/40/44/48/52/56/60/64/100/ 104/108/112/116/132/136/140/149/153/157/161/165 IEEE802.11b/IEEE802.11g: Channels 1-11 IEEE802.11n: Channels 1-11 /36/40/44/48/52/56/60/ 64/100/104/108/112/116/132/136/140/149/153/157/161/165
RF Frequency Band	IEEE802.11a: 5.18 GHz - 5.32 GHz, 5.5 GHz - 5.7 GHz, 5.745 GHz - 5.825 GHz IEEE802.11b/IEEE802.11g: 2.412 GHz - 2.462 GHz IEEE802.11n: 2.412 GHz - 2.462 GHz, 5.18 GHz - 5.32 GHz, 5.5 GHz - 5.7 GHz, 5.745 GHz - 5.825 GHz

■ Bluetooth™ <Only for model with Bluetooth>

Bluetooth Version	2.1 + EDR
Transmission method	FHSS system
Wireless Channels Used	79 channels
RF Frequency Band	2.402GHz - 2.480 GHz

*1 1 KB = 1,024 bytes / 1 MB = 1,048,576 bytes / 1 GB = 1,073,741,824 bytes

*2 A segment of the main memory is allotted automatically depending on the computer's operating status. The size of the Video Memory cannot be set by the user. The size of Video memory is allotted depending on the operating system.

*3 1 GB = 1,000,000,000 bytes. Your operating system or some application software will report as fewer GB.

*4 The monitor will be reduced to the area of 1024 × 600 dots.



Windows 7

Only with 16,777,216 colors can be displayed.

Windows XP

The screen resolution of 1024 × 768 dots may not be chosen with the factory presets depending on the computer's model.

In that case, perform the following procedure to set up the screen resolution of 1024 × 768 dots.

- ① Click [start] - [Control Panel] - [Appearance and Themes] - [Display] - [Settings] - [Advanced] - [Monitor].
 - ② Remove a check mark for [Hide modes that this monitor cannot display] in [Monitor settings], then click [OK].
 - ③ Slide the bar of [Screen resolution] to both sides and choose [1024 by 768 pixels], then click [OK].
 - [Color quality] appearing on the right side of [Screen resolution] needs to be used with [Highest [32 bit]].
- *5 A 16,777,216 color display is achieved by using the dithering function.
- *6 Only for model with Wireless LAN.
- *7 Only for model with Bluetooth.
- *8 Only for model with GPS.
- *9 Only for model with wireless WAN. The specification may differ depending on the models.
- *10 Only for model with that supports TPM. For information on TPM, refer to the Installation Manual of “Trusted Platform Module (TPM)”.
- Windows 7** click  (Start) and input “c:\util\drivers\tpm\README.pdf” in [Search Programs and files] and press  (Enter).
- Windows XP** click [start] - [Run] and input “c:\util\drivers\tpm\README.pdf”.
- *11 This slot is compatible with High-Speed Mode. Operation has been tested and confirmed using Panasonic SD/SDHC Memory Cards with a capacity of up to 32 GB. Operation on other SD equipment is not guaranteed.
- *12 Does not guarantee operation of all USB-compatible peripherals.
- *13 Only for model with Fingerprint Reader.
- *14 The AC adaptor is compatible with power sources up to 240 V AC adaptor. The unit for North America (identified by the suffix ‘M’ on the model number) is supplied with a 125 V AC compatible AC cord. 20-M-1-1
- *15 Measured using MobileMark™ 2007 (LCD brightness: 60 cd/m²)
Varies depending on the usage conditions, or when an external device is attached.
- *16 Varies depending on the usage conditions.
- *17 Approx. 0.9 W when the battery pack is fully charged (or not being charged) and the computer is OFF.
<When using with 115 V AC>
Even when the AC adaptor is not connected to the computer, power is consumed (Max. 0.5 W) simply by having the AC adaptor plugged into an AC outlet.
- *18 Rated power consumption 23-E-1
- *19 Do not expose the skin to this product when using the product in a hot or cold environment. (→ page 14)
When using in hot or cold environment, some peripherals may fail to work properly. Check the operation environment of the peripherals. Using this product continuously in a hot environment will shorten the product life. Avoid use in these types of environments. When using in low temperature environment, startup may become slow or battery operation time may become short. The computer consumes power when the hard disk is warming up during startup. Therefore, if you are using battery power and the remaining power is low, the computer may not start up.
- *20 Operations of this computer are not guaranteed except for the pre-installed OS and the OS which is installed by using the Product Recovery DVD-ROM provided by Panasonic. Some parts of the software in the Product Recovery DVD-ROM may not be installed depending on a model.
- *21 The downgrade service is available only for corporate users who fulfill certain conditions.
- *22 Must be installed before use.
- *23 The Product Recovery DVD-ROM is required.
- *24 These are speeds specified in IEEE802.11a+b+g+n standards. Actual speeds may differ. Data Transfer Rates is automatically switched.

LIMITED WARRANTY

For U.S.A.

Panasonic System Communications Company of North America

Laptop Computer Products - Worldwide Product Warranties

Section 1 - Limited Warranty - Hardware

Panasonic System Communications Company of North America (referred to as “Panasonic”) will repair the products listed below with new or rebuilt parts, free of charge in the U.S.A. or other Panasonic approved location for the period specified below from the date of original purchase in the event of a defect in materials or workmanship. These warranties are extended solely to the original purchaser. A purchase receipt or other proof of date of original purchase will be required before warranty performance is rendered.

- Laptop Computers (CF-##) – 3 Years
- PDRC - LCD and Keyboard Assy – 3 Years
- Ultra-Mobile PC (CF-U/CF-H series) – 3 Years
- MDWD (CF-07/CF-08) – 3 Years

Main Battery

Batteries supplied with the product are covered under the warranty for one (1) year from date of purchase, except as excluded in Section 3. Batteries purchased separately are covered under the warranty for one (1) year from the date of purchase. A battery furnished under the warranty is covered for the remaining period of the one year warranty on the original or purchased battery.

Optional: Panasonic Toughbook Protection Plus Warranty

Any unit for which the Panasonic Toughbook “Protection Plus” warranty has been purchased will receive additional coverage for any failure that occurs due to accidental damage. All other terms and conditions of the standard warranty apply and this additional coverage will exist for the duration of the standard warranty period of the unit. If a four or five year Protection Plus warranty program is purchased, coverage is extended to the end of the fourth or fifth year accordingly.

This warranty covers failures or defects that are not caused by fire, intentional acts, cosmetic damage not affecting functionality, loss, theft, improper maintenance, modification or service by anyone other than the Panasonic National Service Center or a Panasonic Authorized Service Provider, or damage that is attributable to acts of God. This warranty is extended solely to the original purchaser. Maximum benefit is limited to one replacement per coverage year of the Motherboard, LCD, Storage Drive, and Keyboard. Complete unit replacement is at the discretion of Panasonic and is limited to once during the coverage term.

Options and Accessories Warranty

The below listed Panasonic brand or supplied options and accessories are covered under this limited warranty for the period specified from the date of purchase or as specifically stated:

- AC Adaptor / Power Cord – 3 Years
- Memory Expansion Card (Panasonic Brand) – 3 Years
- Car Mount Docking Station PCB or Complete Vehicle Docking Station – 3 Years
- Desktop Dock / Port Replicator / I-O Box / Docking Cradle (like CF-08 / CF-U1) – 3 Years
- Antenna Pass-through Cable – 3 Years
- Backlit or Full-sized keyboard - 3 Years or assumes warranty of the unit in which it is installed
- Integrated Panasonic supplied options and kits including, but not limited to Wireless Modems, Media Bay Drives (Floppy, CD, DVD), Camera, GPS, Bluetooth, Smartcard Reader, Magnetic Card Reader, Barcode Scanner, and Fingerprint Readers – 3 Years or assumes warranty period of the unit in which it is installed provided the integration was performed by Panasonic or an Authorized Integrator.
- Hard Drive (separately purchased) – 1 Year
- External USB Drives (CD / DVD / Floppy / Hard Drive) – 1 Year
- Optional Battery – 1 Year
- Battery Charger – 1 Year
- Stylus Pens, Digitizer & Standard – 90 Days (physical damage excluded)

Section 2 - Limited Warranty - Software

Panasonic System Communications Company of North America (referred to as “Panasonic”) warrants to you only that the disk(s) or other media on which the Programs are furnished will be free from defects in material and workmanship under normal use for a period of sixty (60) days from the date of delivery thereof to you, as evidenced by your purchase receipt.

This is the only warranty Panasonic makes to you. Panasonic does not warrant that the functions contained in the Programs will meet your requirements or that the operation of the Programs will be uninterrupted or error free. Panasonic shall have no obligation for any defects in the disk(s) or other media on which the Programs are furnished resulting from your storage thereof, or for defects that have been caused by operation of the disk(s) or other media

Panasonic’s entire liability and your exclusive remedy under this warranty shall be limited to the replacement, in the United States or other Panasonic designated location, of any defective disk or other media which is returned to Panasonic’s Authorized Service Center, together with a copy of the purchase receipt, within the aforesaid warranty period.

Section 3 - Limited Warranty Exclusions - Specifically excluded from the warranty are:

- All consumable items; such as screen protection films, logo badges, labels, cleaning cloths, carry cases, manuals, cables, straps, belts, holsters, tethers, and harnesses and any other options and accessories not listed above or covered under a separate warranty.
- Failures related to the product operating system, hard drive image, software setup, software program, virus, other program(s) or file(s) on the hard drive or in any computer memory location.
- Failures due to BIOS settings or changes, as well as any cosmetic or physical damage to the unit.

LIMITED WARRANTY

- Any unit or device with a missing or altered model number or serial number label
- Damage which occurs in shipment
- Failures which are caused by products not supplied by Panasonic
- Failures which result from alteration, accident, misuse, introduction of liquid or other foreign matter into the unit, abuse, neglect, installation, maladjustment of consumer controls, improper maintenance or modification, use not in accordance with product use instructions
- Failures due to service by anyone other than a Panasonic Authorized Service Provider
- Failures caused by improper installation of options or accessories or due to integration by any company other than Panasonic Configuration and Integration Centers
- Damage, failure, or loss due to the unit being stolen, lost, misplaced, or used by anyone other than the original purchaser
- Damage that is attributable to acts of God

This limited warranty only covers failures due to defects in materials or workmanship which occur during normal use. If a unit is sent to a Panasonic Authorized Service Center and no hardware failure is found, the customer will be billed for labor to correct a software issue or reimage the hard drive plus shipping and applicable administrative fees at the current rates set by the service provider.

THIS PRODUCT IS NOT INTENDED FOR USE AS OR AS PART OF NUCLEAR EQUIPMENT/SYSTEMS, AIR TRAFFIC CONTROL EQUIPMENT/SYSTEMS, OR AIRCRAFT COCKPIT EQUIPMENT/SYSTEMS^{*1}. PANASONIC WILL NOT BE RESPONSIBLE FOR ANY LIABILITY RESULTING FROM THE USE OF THIS PRODUCT ARISING OUT OF THE FOREGOING USES.

^{*1} AIRCRAFT COCKPIT EQUIPMENT/SYSTEMS include Class 2 Electronic Flight Bag (EFB) Systems and Class 1 EFB Systems when used during critical phases of flight (e.g., during take-off and landing) and/or mounted onto the aircraft. Class 1 EFB Systems and 2 EFB Systems are defined by FAA: AC (Advisory Circular) 120-76A or JAA: JAA TGL (Temporary Guidance Leaflets) No.36.

Other Limits and Exclusions: There are no other express warranties except as listed above.

PANASONIC SHALL NOT BE LIABLE FOR LOSS OF DATA OR OTHER INCIDENTAL OR CONSEQUENTIAL DAMAGES RESULTING FROM THE USE OF THIS PRODUCT, OR ARISING OUT OF ANY BREACH OF THIS WARRANTY. ALL EXPRESS AND IMPLIED WARRANTIES, INCLUDING THE WARRANTIES OF MERCHANTABILITY AND FITNESS FOR A PARTICULAR PURPOSE ARE LIMITED TO THE APPLICABLE WARRANTY PERIOD SET FORTH ABOVE. Some states do not allow the exclusion or limitation of incidental or consequential damages, or limitations on how long an implied warranty lasts, so the above limitations or exclusions may not apply to you.

This limited warranty gives you specific legal rights, and you may also have other rights which vary from state to state.

For technical support or to arrange for service on your Panasonic computer product, call our toll-free hotline at 1-800-LAPTOP5.

DIAL TOLL FREE: 1-800-LAPTOP5 (1-800-527-8675)
Web Site : www.panasonic.com/toughbook

For Canada

PANASONIC COMPUTER AND PERIPHERALS LIMITED WARRANTY

Coverage – Panasonic Canada Inc. (“PCI”) warrants to you, the first end user customer, this computer product (excluding software media), when purchased from PCI or from a PCI authorized reseller, to be free from defects in materials and workmanship under normal use, subject to the terms set forth below, during the period of warranty coverage specified.

Scope of Coverage	Period of Coverage	Type of Failure Coverage
<ul style="list-style-type: none"> • Laptop Computers (except Battery) and AC Adaptor • Factory/PCI installed options including Wireless WAN, GPS, Bluetooth, Fingerprint reader, Backlit keyboard, Memory Card and Media Bay Drives (Floppy, CD/DVD) • Ultra-Mobile PC • Mobile Wireless Display • PDRC – LCD and Keyboard Assemblies • Port Replicator 	Three (3) Years from Date of Original End User Customer Purchase	Defective Materials or Workmanship
<ul style="list-style-type: none"> • Hand-held Computers • Battery • Battery charger • Auto Adaptor • External USB Drives 	One (1) Year from Date of Original End User Customer Purchase	Defective Materials or Workmanship
<ul style="list-style-type: none"> • Standard or Digitizer Stylus Pen 	Ninety (90) Days from Date of Original End User Customer Purchase	Defective Materials or Workmanship
<ul style="list-style-type: none"> • All consumable items including protection film, cleaning cloth, carry case, tether and harness 	No Coverage	

Remedy – In the event of a warranty claim, contact PCI’s representatives within the applicable warranty period, identifying the nature of the defect claimed, at 1-800-668-8386 between 9:00 A.M. and 5:00 P.M., Eastern Time Zone, Mon. – Fri. (excluding holidays) for instructions on how to obtain service. A purchase receipt or other proof of date of original purchase is required before warranty service is performed. Defective parts covered by this Limited Warranty will be repaired or replaced with new or comparable rebuilt parts on an exchange basis. Warranty replacement or repair is subject to the terms of this Limited Warranty for the balance of the original period of warranty coverage.

No Coverage – This Limited Warranty does not cover products purchased outside Canada. Neither does it cover damage to, failure of, or defects in a product or accessory through mishandling, improper installation, abnormal use, misuse, neglect, accident, introduction of liquid or other foreign matter into the product, alteration or servicing by anyone not authorized by PCI, or act of God.

THIS PRODUCT IS NOT INTENDED FOR USE AS, OR AS PART OF, NUCLEAR EQUIPMENT/SYSTEMS, AIR TRAFFIC CONTROL EQUIPMENT/SYSTEMS, OR AIRCRAFT COCKPIT EQUIPMENT/SYSTEMS². PANASONIC WILL NOT BE RESPONSIBLE FOR ANY LIABILITY RESULTING FROM THE USE OF THIS PRODUCT ARISING OUT OF THE FOREGOING USES.

LIMITED WARRANTY

² AIRCRAFT COCKPIT EQUIPMENT/SYSTEMS include Class 2 Electronic Flight Bag (EFB) Systems and Class 1 EFB Systems when used during critical phases of flight (e.g., during take-off and landing) and/or mounted on to the aircraft. Class 1 EFB Systems and 2 EFB Systems are defined by FAA: AC (Advisory Circular) 120-76A or JAA: JAA TGL (Temporary Guidance Leaflets) No.36

IF YOU SHIP THE PRODUCT FOR WARRANTY SERVICE

Carefully pack the product, preferably in the original carton. Include details of defect claimed and proof of date of original purchase. No liability is assumed for loss or damage to the product while in transit, if you chose your own transportation carrier.

SOFTWARE MEDIA LIMITED WARRANTY

Coverage – PCI warrants to you, the first end user customer, that the disk(s) or other media on which software program(s) is/are supplied will be free from defects in materials and workmanship under normal use in Canada for a period of sixty (60) days from date of receipt as evidenced by your purchase receipt for your Panasonic Computer product. THIS IS THE ONLY WARRANTY THAT PCI MAKES RESPECTING THE SOFTWARE MEDIA. PCI does not warrant the software. Please refer to the software licensor's written warranty (accompanying the copy of the software) for any software warranty claim.

Claim Procedure – In the event of a defect in material or workmanship in the media during the sixty (60) days warranty period, and you return it, transportation costs prepaid, to Panasonic Canada Inc., Computer Products Marketing, 5770 Ambler Drive, Mississauga, Ontario L4W 2T3, within the warranty period, together with a copy of your purchase receipt, and an explanation of the suspected defect, PCI will replace in Canada the defective disk(s) or other media.

Remedy – PCI's entire liability, and your only remedy for any breach of this software media warranty is limited to replacement of the media only. It does not cover any other damages, including, but not limited to, loss of use or profit loss, or special, indirect or consequential damages, or other claims, whether or not of similar character.

No Coverage – This limited warranty does not apply if the disk(s) or other media has been used in other than a Panasonic product, or in environmental conditions other than those specified by PCI or the manufacturer, or if subjected to misuse, neglect, mishandling, modification or attempted modification of the program, or if damaged by accident or act of God. PCI is not responsible for damage to or loss of any program, data or removable storage media.

GENERAL

NO OTHER WARRANTIES – PCI DISCLAIMS ALL OTHER WARRANTIES, EITHER EXPRESS OR IMPLIED, INCLUDING, BUT NOT LIMITED TO, IMPLIED WARRANTIES OF MERCHANTABILITY AND FITNESS FOR A PARTICULAR PURPOSE, WITH RESPECT TO THE SOFTWARE, SOFTWARE MEDIA, COMPUTER PRODUCT, OPTIONS AND ACCESSORIES.

NO LIABILITY FOR CONSEQUENTIAL DAMAGES – IN NO EVENT SHALL PCI BE LIABLE FOR ANY SPECIAL, INDIRECT OR CONSEQUENTIAL DAMAGES ARISING FROM ANY BREACH OF THE LIMITED WARRANTIES SET OUT IN THIS DOCUMENT, OR FROM THE USE OF THE COMPUTER PRODUCT, INCLUDING, WITHOUT LIMITATION, LOSS OF DATA, BUSINESS, PROFIT OR GOODWILL.

IN ANY EVENT, PCI'S MAXIMUM LIABILITY FOR ANY BREACH SHALL NOT EXCEED THE AMOUNT ACTUALLY PAID BY YOU FOR THE COMPUTER PRODUCT.

NO ACTION, REGARDLESS OF ITS BASIS, MAY BE BEGUN AGAINST PCI MORE THAN TWO (2) YEARS AFTER THE CAUSE OF ACTION AROSE.

Statutory Warranties – Some jurisdictions do not allow these limitations or exclusions, so they may not apply to you.

GARANTIE LIMITÉE

Pour le Canada

GARANTIE LIMITÉE – ORDINATEURS ET PÉRIPHÉRIQUES PANASONIC

Couverture – Panasonic Canada Inc. (« PCI ») garantit à l'acheteur original que ce produit informatique (à l'exclusion des supports des logiciels) est, au moment de sa vente par PCI ou d'un revendeur agréé par PCI, exempt de défauts de pièces et de fabrication dans les conditions normales d'utilisation, et ce, pendant la période de couverture de la garantie, sous réserve des modalités décrites ci-dessous.

Éléments couverts	Durée de couverture	Type de couverture
<ul style="list-style-type: none">• Ordinateurs blocs-notes (sauf batteries) et adaptateur secteur• Options installées en usine/par PCI incluant : WAN sans fil, GPS, Bluetooth, lecteur d'empreintes digitales, clavier rétroéclairé, carte mémoire et lecteurs (disquettes, CD/DVD)• Ordinateurs personnels ultra-portables• Écran mobile sans fil• Ensembles PDRC – ACL et clavier• Duplicateur de port	Trois (3) ans à partir de la date d'achat original.	Défauts de pièces et de fabrication
<ul style="list-style-type: none">• Ordinateurs de poche• Batterie• Chargeur de batterie• Adaptateur pour voiture• Périphériques USB	Un (1) an à partir de la date d'achat original.	Défauts de pièces et de fabrication
<ul style="list-style-type: none">• Stylo pointeur standard ou pour numériseur graphique	Quatre-vingt-dix (90) jours à partir de la date d'achat original.	Défauts de pièces et de fabrication
<ul style="list-style-type: none">• Tous les articles consommables incluant les pellicules protectrices, chiffons de nettoyage, étuis de transport, langes et sangles	Aucune couverture	

Recours – Pour obtenir des informations sur la marche à suivre dans le cas où une réclamation en vertu de la garantie deviendrait nécessaire, communiquez par téléphone avec un représentant de PCI au 1-800-668-8386, entre 9h00 et 17h00 (heure de l'Est) du lundi au vendredi (sauf les jours fériés), avant l'échéance de la garantie applicable, en prenant soin d'identifier la nature de la défaillance.

Un reçu ou toute autre pièce justificative de la date d'achat original sera exigé avant toute réparation. Toute pièce défectueuse couverte par la présente garantie limitée sera réparée ou remplacée par une pièce neuve ou remise à neuf. Le remplacement ou la réparation sera fait conformément aux modalités de la présente garantie limitée pendant la durée restante de la période originale de la garantie.

Produits non couverts – La présente garantie limitée ne couvre pas les produits achetés à l'extérieur du Canada. Elle ne couvre pas non plus les dommages, la défaillance ou les défauts attribuables à une manutention inadéquate, une mauvaise installation, une

GARANTIE LIMITÉE

utilisation anormale ou abusive, de la négligence, un accident, un déversement ou la pénétration d'un objet étranger, une modification, un cas fortuit ou une réparation effectuée par une personne non agréée par PCI.

CE PRODUIT N'EST PAS DESTINÉ À ÊTRE UTILISÉ, EN TOUT OU EN PARTIE, COMME SYSTÈME/ÉQUIPEMENT NUCLÉAIRE, SYSTÈME/ÉQUIPEMENT DE CONTRÔLE DU TRAFFIC AÉRIEN OU SYSTÈME/ÉQUIPEMENT DE POSTE DE PILOTAGE D'AVION^{*3}. PANASONIC DÉCLINE TOUTE RESPONSABILITÉ CONCERNANT L'UTILISATION DE CE PRODUIT DANS LES CAS SUSMENTIONNÉS.

^{*3} Les SYSTÈMES/ÉQUIPEMENTS DE POSTE DE PILOTAGE D'AVION sont dotés de systèmes OEPP (organiseur électronique de poste de pilotage) de classe 2 et de classe 1 utilisés pendant des phases critiques de vol (par exemple, pendant le décollage et l'atterrissage) et/ou montés sur l'avion. Les systèmes OEPP de classe 1 et de classe 2 sont définis par le circulaire d'information FAA: AC (Advisory Circular) 120-76A ou le feuillet n° 36 JAA: JAA TGL (Temporary Guidance Leaflets) No 36.

EXPÉDITION DU PRODUIT POUR SERVICE SOUS GARANTIE

Emballez soigneusement le produit, de préférence dans son emballage d'origine.

Joignez une description de la défaillance de même qu'une pièce justificative de la date d'achat. Panasonic Canada Inc. ne peut être tenue responsable pour tout dommage ou perte subi pendant le transport si vous avez choisi le transporteur.

GARANTIE LIMITÉE – SUPPORTS DES LOGICIELS

Couverture – Panasonic Canada Inc. (« PCI ») garantit à l'acheteur original que la ou les disquettes ou tout autre support sur lequel le ou les programmes sont fournis sont exempts de défauts de pièces et de fabrication dans des conditions normales d'utilisation au Canada, et ce, pour une période de soixante (60) jours suivant la date de réception indiquée sur la preuve d'achat.

LA PRÉSENTE GARANTIE EST LA SEULE OFFERTE PAR PCI COUVRANT LES SUPPORTS DE LOGICIELS. PCI ne garantit pas les logiciels. Reportez-vous à la garantie écrite du concédant de licence d'utilisation du logiciel (qui accompagne la copie du logiciel) pour toute réclamation en vertu de la garantie.

Réclamation – marche à suivre – Panasonic Canada Inc. remplacera toute disquette ou support défectueux si l'article en question est retourné, port payé, à son service de Marketing – produits informatiques, 5770 Ambler Drive, Mississauga (Ontario) L4W 2T3, dans les soixante (60) jours suivant la date d'achat original. Joignez à votre envoi une pièce justificative de votre achat et une description du problème.

Recours – La responsabilité de PCI - et votre seul recours - dans le cas de toute défaillance couverte par la garantie sur ce support de logiciel est limitée au seul remplacement du support. Elle ne couvre aucun autre dommage, y compris, mais non exclusivement, la perte d'usage ou de profits, ni aucun dommage spécial, indirect ou consécutif, ni aucune autre réclamation de nature similaire ou autre.

Produits non couverts – La présente garantie limitée ne s'applique pas si la ou les disquettes ou autre support ont été utilisés dans un produit d'une marque autre que Panasonic ou dans des conditions environnementales autres que celles spécifiées par PCI ou le fabricant, ou soumis à une mauvaise utilisation, à la négligence, à une manutention inadéquate ou encore si le programme a été modifié ou subi une tentative de modification ou des dommages attribuables à un accident ou à un cas fortuit. De plus, PCI n'assume aucune responsabilité pour toute perte de, ou tout dommage à, un programme, des données ou un support de sauvegarde amovible.

GÉNÉRALITÉS

PCI NE RECONNAÎT AUCUNE AUTRE GARANTIE, EXPLICITE OU IMPLICITE, Y COMPRIS, MAIS NON EXCLUSIVEMENT, LES GARANTIES IMPLICITES DE VALEUR COMMERCIALE ET D'UTILITÉ À UNE FIN QUELCONQUE, À L'ÉGARD DU LOGICIEL, SUPPORTS DE LOGICIELS, PRODUITS INFORMATIQUES, PÉRIPHÉRIQUES ET ACCESSOIRES.

SOUS AUCUNE CIRCONSTANCE PCI NE POURRA ÊTRE TENUE RESPONSABLE DES DOMMAGES SPÉCIAUX, INDIRECTS OU CONSÉCUTIFS ATTRIBUABLES À UN MANQUEMENT AUX GARANTIES LIMITÉES DÉCRITES DANS LE PRÉSENT DOCUMENT OU À L'UTILISATION DU PRODUIT INFORMATIQUE, Y COMPRIS, SANS RESTRICTION, LA PERTE DE DONNÉES, D'AFFAIRES, D'ACHALANDAGE OU DE PROFIT.

DANS TOUS LES CAS, LA RESPONSABILITÉ MAXIMALE DE PCI POUR TOUT MANQUEMENT NE POURRA EXCÉDER LE PRIX DE VENTE DU PRODUIT INFORMATIQUE.

AUCUNE RÉCLAMATION, SANS ÉGARD À SES MOTIFS, NE POURRA ÊTRE FAITE AUPRÈS DE PCI PLUS DE DEUX (2) ANS APRÈS LES FAITS INVOQUÉS À LA BASE D'UNE TELLE RÉCLAMATION.

Garantie statutaires – Certaines juridictions interdisent de telles limitations ou exclusions; aussi, pourraient-elles ne pas s'appliquer.

MEMO



As an ENERGY STAR® Partner, Panasonic Corporation has determined that this product meets ENERGY STAR® guidelines for energy efficiency. By enabling available power management settings, Panasonic computers enter a low-power sleep mode after a period of inactivity, saving the user energy. To learn more about power management, please visit the web site:

www.energystar.gov/index.cfm?c=power_mgt.pr_power_management

Outline of the International ENERGY STAR® Office Equipment Program

The international ENERGY STAR® Office Equipment Program is an international program that promotes energy saving through the use of computers and other office equipment. The program backs the development and dissemination of products with functions that effectively reduce energy consumption. It is an open system in which business proprietors can participate voluntarily. The targeted products are office equipment such as computers, displays, printers, facsimiles, and copiers. Their standards and logos are uniform among participating nations.

For information about ENERGY STAR®, refer to the following web site:

Web Site: www.energystar.gov

22-M-1

**Panasonic System Communications Panasonic Canada Inc.
Company of North America**

3 Panasonic Way, Panazip 2F-5,
Secaucus, NJ 07094

5770 Ambler Drive, Mississauga,
Ontario L4W 2T3

© Panasonic Corporation 2012
Printed in Japan

SS0112-0
DFQW5622ZA

