

OPERATING INSTRUCTIONS Tablet Computer

Model No. **FZ-A1** series

Contents

Read Me First

| | |
|------------------------------|---|
| Safety Precautions | 2 |
| Regulatory Information | 6 |

Getting Started

| | |
|---|----|
| Introduction | 12 |
| Description of Parts | 13 |
| First-time Operation | 15 |
| Turning On/Off and Sleeping/Waking Up | 18 |
| Input Operation | 19 |

Useful Information

| | |
|--------------------------------|----|
| Handling and Maintenance | 21 |
|--------------------------------|----|

Troubleshooting

| | |
|-------------------------------|----|
| Troubleshooting (Basic) | 24 |
|-------------------------------|----|

Appendix

| | |
|----------------------|----|
| Specifications | 27 |
|----------------------|----|

For further information about this computer, you can refer to the on-screen manual by performing the following steps.

Touch

 - [ OnlineManual].

When more than one on-screen manuals are prepared, name of those manuals are listed in above step. Touch a manual to access from the list.

Safety Precautions

To reduce the risk of injury, loss of life, electric shock, fire, malfunction, and damage to equipment or property, always observe the following safety precautions.

Explanation of symbol word panels

The following symbol word panels are used to classify and describe the level of hazard, injury, and property damage caused when the denotation is disregarded and improper use is performed.

DANGER

Denotes a potential hazard that will result in serious injury or death.

WARNING

Denotes a potential hazard that could result in serious injury or death.

CAUTION

Denotes a hazard that could result in minor injury.

NOTICE

Denotes a hazard that could result in property damage.

The following symbols are used to classify and describe the type of instructions to be observed.

 This symbol is used to alert users to a specific operating procedure that must not be performed.

 This symbol is used to alert users to a specific operating procedure that must be followed in order to operate the unit safely.



WARNING



Do Not Charge the Battery Using Methods Other Than Those Specified

If the battery is not charged using one of the specified methods, electrolyte leakage, generation of heat, ignition or rupture of the battery may result.



Do Not Throw the Product Into a Fire or Expose It to Excessive Heat

Generation of heat, ignition or rupture of the battery may result.



Avoid Extreme Heat (Near the Fire, In Direct Sunlight, for Example)

Electrolyte leakage, generation of heat, ignition or rupture of the battery may result.



Do Not Insert Sharp Objects Into the Internal Battery, Disassemble, or Modify It

Electrolyte leakage, generation of heat, ignition or rupture of the battery may result.



Do Not Apply Shocks to the Product by Dropping It, Applying Strong Pressure to It, etc.

Electrolyte leakage, generation of heat, ignition or rupture of the battery may result.

- If this product is subjected to a strong impact, stop using it immediately.



When the battery has deteriorated, contact your technical support office to replace the battery

Continued use of a damaged battery may result in heat generation, ignition or battery rupture.



WARNING



If a Malfunction or Trouble Occurs, Immediately Stop Use

If a Malfunction Occurs, Immediately Unplug the AC Plug

- This product is damaged
- Foreign object is inside this product
- Smoke emitted
- Unusual smell emitted
- Unusually hot

Continuing to use this product while any of the above conditions are present may result in fire or electric shock.

- If a malfunction or trouble occurs, immediately turn the power off and unplug the AC plug. Then contact your technical support office for repair.



Do Not Touch This Product in a Thunderstorm If Connected with the AC Cable or Any Other Cables

Electric shock may result.



Do Not Connect the AC Adaptor to a Power Source Other Than a Standard Household AC Outlet

Otherwise, a fire due to overheating may result. Connecting to a DC/AC converter (inverter) may damage the AC adaptor. On an airplane, only connect the AC adaptor/charger to an AC outlet specifically approved for such use.



Do Not Do Anything That May Damage the AC Cord, the AC Plug, or the AC Adaptor

Do not damage or modify the cord, place it near hot tools, bend, twist, or pull it forcefully, place heavy objects on it, or bundle it tightly. Continuing to use a damaged cord may result in fire, short circuit, or electric shock.



Do Not Pull or Insert the AC Plug If Your Hands Are Wet

Electric shock may result.



Clean Dust and Other Debris of the AC Plug Regularly

If dust or other debris accumulates on the plug, humidity, etc. may cause a defect in the insulation, which may result in a fire.

- Pull the plug, and wipe it with a dry cloth. Pull the plug if the computer is not being used for a long period of time.



Insert the AC Plug Completely

If the plug is not inserted completely, fire due to overheating or electric shock may result.

- Do not use a damaged plug or loose AC outlet.



Close the Connector Cover Tightly When Using This Product Where Is a Lot of Water, Moisture, Steam, Dust, Oily Vapors, etc.

The entry of foreign matter may cause a fire or electric shocks.

- If foreign matter has found its way inside, immediately turn the power off and unplug the AC cord. Then contact your technical support office.



Do Not Disassemble This Product

You may receive an electric shock, or foreign matter may enter and result in a fire.



Keep microSD Memory Cards Away from Infants and Small Children

Accidental swallowing will result in bodily injury.

- In the event of accidental swallowing, see a doctor immediately.



Do Not Use With Exposing the Skin To This Product For a Long Period of Time

Using this product with exposing the skin to the heat source of this product or AC adaptor for a long period of time can cause a low-temperature burn.



Do Not Turn the Volume Up To Loud When Using Headphones

Listening at high volumes that overstimulate the ear for long periods of time may result in loss of hearing.



CAUTION



Do Not Place This Product on Unstable Surfaces

If balance is lost, this product may fall over or drop, resulting in an injury.



Avoid Stacking

If balance is lost, this product may fall over or drop, resulting in an injury.

Safety Precautions



CAUTION



Do Not Leave This Product in High Temperature Environment for a Long Period of Time

Leaving this product where it will be exposed to extremely high temperatures such as near fire or in direct sunlight may deform the cabinet and/or cause trouble in the internal parts. Continued use in such a resulting condition may lead to short-circuiting or insulation defects, etc. which may in turn lead to a fire or electric shocks.



Hold the Plug When Unplugging the AC Plug

Pulling on the cord may damage the cord, resulting in a fire or electric shock.



Do Not Move This Product While the AC Plug Is Connected

The AC cord may be damaged, resulting in fire or electric shock.

- If the AC cord is damaged, unplug the AC plug immediately.



Use Only the Specified AC Adaptor With This Product

Using an AC adaptor other than the one supplied (supplied with the unit or one sold separately as an accessory) may result in a fire.



Do Not Subject the AC Adaptor To Any Strong Impact

Using the AC adaptor after a strong impact such as being dropped may result in electric shock, short circuit, or fire.



Take a Break Of 10-15 Minutes Every Hour

Using this product for long periods of time may have detrimental health effects on the eyes or hands.



Do Not Expose the Skin To This Product When Using the Product In A Hot Or Cold Environment

Burns, low-temperature burns, or frostbite may result.

- When it is necessary to expose the skin to this product such as to scan a fingerprint, perform the operation in the shortest time possible.

NOTICE

- Do not place the computer near a television or radio receiver.
- Keep the computer away from magnets. Data stored on the flash memory may be lost.
- This computer is not intended for the display of images for use in medical diagnosis.
- This computer is not intended for a use with connection of medical equipment for the purpose of medical diagnosis.
- Panasonic shall not be liable for loss of data or other incidental or consequential damages resulting from the use of this product.
- If this computer will not be used for a long period of time (a month or more), charge or discharge (use) the battery until the remaining battery level becomes 30 % to 40 % and store the product in a cool, dry place.
- This computer prevents overcharging of the battery by recharging only when the remaining power is less than approx. 95 % of capacity.
- The battery is not charged when this computer is first purchased. Be sure to charge it before using it for the first time. When the AC adaptor is connected to this computer, charging begins automatically.
- Should the battery leak and the fluid get into your eyes, do not rub your eyes. Immediately flush your eyes with clear water and see a doctor for medical treatment as soon as possible.

NOTE

- The battery may become warm during recharging or normal use. This is completely normal.
- Recharging will not commence if internal temperature of the battery is outside of the allowable temperature range (0 °C to 50 °C). Once the allowable range requirement is satisfied, charging begins automatically. Note that the recharging time varies based on the usage conditions. (Recharging takes longer than usual when the temperature is 10 °C or below.)
- If the temperature is low, the operating time is shortened. Only use the computer within the allowable temperature range.
- The battery is a consumable item. If the amount of time the computer can be run by using a particular battery becomes dramatically shorter and repeated recharging does not restore its performance, the battery should be replaced with a new one. Contact your technical support office.

- Always power off the computer when it is not in use. Leaving the computer on when the AC adaptor is not connected will exhaust the remaining battery capacity.

THIS PRODUCT IS NOT INTENDED FOR USE AS, OR AS PART OF, NUCLEAR EQUIPMENT/SYSTEMS, AIR TRAFFIC CONTROL EQUIPMENT/SYSTEMS, AIRCRAFT COCKPIT EQUIPMENT/SYSTEMS *1, MEDICAL DEVICES OR ACCESSORIES *2, LIFESUPPORT SYSTEMS OR OTHER EQUIPMENTS/ DEVICES/SYSTEMS THAT ARE INVOLVED WITH ENSURING HUMAN LIFE OR SAFETY. PANASONIC WILL NOT BE RESPONSIBLE FOR ANY LIABILITY RESULTING FROM THE USE OF THIS PRODUCT ARISING OUT OF THE FOREGOING USES.

*1 AIRCRAFT COCKPIT EQUIPMENT/ SYSTEMS include Class2 Electrical Flight Bag (EFB) Systems and Class1 EFB Systems when used during critical phases of flight (e.g., during take-off and landing) and/or mounted on to the aircraft. Class1 EFB Systems and 2 EFB Systems are defined by FAA: AC (Advisory Circular) 120-76A or JAA: JAA TGL (Temporary Guidance Leaflets) No.36.

*2 As defined by the European Medical Device Directive (MDD) 93/ 42/EEC.

Panasonic cannot guarantee any specifications, technologies, reliability, safety (e.g. Flammability/ Smoke/Toxicity/Radio Frequency Emission, etc) requirements related to aviation standards and medical equipment standards that differ from the specifications of our COTS (Commercial-Off-The-Shelf) products.

This computer is not intended for use in medical equipment including life-support systems, air traffic control systems, or other equipment, devices or systems that are involved with ensuring human life or safety. Panasonic cannot be held responsible in any way for any damages or loss resulting from the use of this unit in these types of equipment, devices or systems, etc.

This computer has been designed so as to minimize shock to the LCD, the leakage of liquid (e.g., water) on to the buttons, etc., but no warranty is provided against such trouble. Therefore, as a precision instrument, be extremely careful in the handling.

Regulatory Information

Information to the User

This product and your Health

This product, like other radio devices, emits radio frequency electromagnetic energy. The level of energy emitted by this product however is far much less than the electromagnetic energy emitted by wireless devices like for example mobile phones. Because this product operates within the guidelines found in radio frequency safety standards and recommendations, we believe this product is safe for use by consumers. These standards and recommendations reflect the consensus of the scientific community and result from deliberations of panels and committees of scientists who continually review and interpret the extensive research literature.

In some situations or environments, the use of this product may be restricted by the proprietor of the building or responsible representatives of the organization. These situations may for example include:

- Using this product on board of airplanes, or
- In any other environment where the risk of interference to other devices or services is perceived or identified as harmful.

If you are uncertain of the policy that applies on the use of wireless devices in a specific organization or environment (e.g. airports), you are encouraged to ask for authorization to use this product prior to turning on the product.

Regulatory Information

We are not responsible for any radio or television interference caused by unauthorized modification of this product. The correction of interference caused by such unauthorized modification will be the responsibility of the user. We and its authorized resellers or distributors are not liable for damage or violation of government regulations that may arise from failing to comply with these guidelines.

26-M-1

Lithium Battery

Lithium Battery!

This computer contains a lithium battery to enable the date, time, and other data to be stored. The battery should only be exchanged by authorized service personnel.

Warning! A risk of explosion from incorrect installation or misapplication may possibly occur.

15-E-1

Information for Users on Collection and Disposal of Old Equipment and used Batteries



These symbols on the products, packaging, and/or accompanying documents mean that used electrical and electronic products and batteries should not be mixed with general household waste.

For proper treatment, recovery and recycling of old products and used batteries, please take them to applicable collection points, in accordance with your national legislation and the Directives 2002/96/EC and 2006/66/EC.

By disposing of these products and batteries correctly, you will help to save valuable resources and prevent any potential negative effects on human health and the environment which could otherwise arise from inappropriate waste handling. For more information about collection and recycling of old products and batteries, please contact your local municipality, your waste disposal service or the point of sale where you purchased the items. Penalties may be applicable for incorrect disposal of this waste, in accordance with national legislation.

For business users in the European Union

If you wish to discard electrical and electronic equipment, please contact your dealer or supplier for further information.



[Information on Disposal in other Countries outside the European Union]

These symbols are only valid in the European Union. If you wish to discard this product, please contact your local authorities or dealer and ask for the correct method of disposal.



Note for the battery symbol (bottom two symbol examples):

This symbol might be used in combination with a chemical symbol. In this case it complies with the requirement set by the Directive for the chemical involved.

53-E-1

Safety Precautions for wireless WAN

<Only for model with wireless WAN>

The following safety precautions must be observed during all phases of the operation, usage, service or repair of any Computer incorporating wireless WAN modem. Manufacturers of the cellular terminal are advised to convey the following safety information to users and operating personnel and to incorporate these guidelines into all manuals supplied with the product. Failure to comply with these precautions violates safety standards of design, manufacture and intended use of the product. Panasonic assumes no liability for customer failure to comply with these precautions.



When in a hospital or other health care facility, observe the restrictions on the use of mobiles. Switch Computer incorporating wireless WAN modem off, if instructed to do so by the guidelines posted in sensitive areas. Medical equipment may be sensitive to RF energy.

The operation of cardiac pacemakers, other implanted medical equipment and hearing aids can be affected by interference from Computer incorporating wireless WAN modem placed close to the device. If in doubt about potential danger, contact the physician or the manufacturer of the device to verify that the equipment is properly shielded. Pacemaker patients are advised to keep their Computer incorporating wireless WAN modem away from the pacemaker, while it is on.



Switch off Computer incorporating wireless WAN modem before boarding an aircraft. Make sure it cannot be switched on inadvertently. The operation of wireless appliances in an aircraft is forbidden to prevent interference with communications systems. Failure to observe these instructions may lead to the suspension or denial of cellular services to the offender, legal action, or both. For details on usage of this unit in aircrafts please consult and follow instruction provided by the airline.



Do not operate Personal Computer or Handheld Computer incorporating wireless WAN modem in the presence of flammable gases or fumes. Switch off the cellular terminal when you are near petrol stations, fuel depots, chemical plants or where blasting operations are in progress. Operation of any electrical equipment in potentially explosive atmospheres can constitute a safety hazard.



Your Computer incorporating wireless WAN modem receives and transmits radio frequency energy while switched on. Remember that interference can occur if it is used close to TV sets, radios, computers or inadequately shielded equipment. Follow any special regulations and always switch off Computer incorporating wireless WAN modem wherever forbidden, or when you suspect that it may cause interference or danger.



Road safety comes first! Do not use a Computer incorporating wireless WAN modem while driving a vehicle. Do not place the computer with wireless WAN modem in an area where it could cause personal injury to the driver or passengers. It is recommended to stow the unit in the boot or secure stowage area while driving. Do not place the computer with wireless WAN modem in an area over an air bag or in the vicinity where an air bag may deploy. Air bags inflate with great force and if the computer with wireless WAN modem is placed in the air bag deployment area may be propelled with great force and cause serious injury to occupants of the vehicle.



IMPORTANT! Computer incorporating wireless WAN modem operate using radio signals and cellular networks cannot be guaranteed to connect in all conditions. Therefore, you should never rely solely upon any wireless device for essential communications, for example emergency calls. Remember, in order to make or receive calls, Computer incorporating wireless WAN modem must be switched on and in a coverage area with adequate cellular signal

Regulatory Information

strength. Some networks do not allow for emergency calls if certain network services or phone features are in use (e.g. lock functions, fixed dialing etc.). You may need to deactivate those features before you can make an emergency call. Some networks require that a valid SIM card be properly inserted in Computer incorporating wireless WAN modem.

Camera Light

CAUTION

Camera Light for rear camera

- The light from the LED is strong and can injure human eyes. Do not look directly at the LEDs with naked eyes.

57-E-1

For U.S.A.

<Models for U.S.A.>

Federal Communications Commission Radio Frequency Interference Statement

Note: This equipment has been tested and found to comply with the limits for a Class B digital device, pursuant to Part 15 of the FCC Rules. These limits are designed to provide reasonable protection against harmful interference in a residential installation. This equipment generates, uses and can radiate radio frequency energy and, if not installed and used in accordance with the instructions, may cause harmful interference to radio communications. However, there is no guarantee that interference will not occur in a particular installation. If this equipment does cause harmful interference to radio or television reception, which can be determined by turning the equipment off and on, the user is encouraged to try to correct the interference by one or more of the following measures:

- Reorient or relocate the receiving antenna.
- Increase the separation between the equipment and receiver.
- Connect the equipment into an outlet on a circuit different from that to which the receiver is connected.
- Consult the Panasonic Service Center or an experienced radio/TV technician for help.

Warning

To assure continued compliance, use only shielded interface cables when connecting to a computer or peripheral. Also, any changes or modifications

not expressly approved by the party responsible for compliance could void the user's authority to operate this equipment.

This device complies with Part 15 of the FCC Rules.

Operation is subject to the following two conditions:

- (1) This device may not cause harmful interference, and
- (2) This device must accept any interference received, including interference that may cause undesired operation.

FCC RF Exposure Warning:

- This device meets the government's requirements for exposure to radio waves. This device is designed and manufactured not to exceed the emission limits for exposure to radio frequency (RF) energy set by the Federal Communications Commission of the U.S. Government.
- This equipment has been approved for portable operation, and does not require any minimum spacing be provided between antennas and all person's body. This equipment may not be colocated or operated with any other antenna or transmitter.
- The exposure standard for wireless device employs a unit of measurement known as the Specific Absorption Rate, or SAR. The SAR limit set by the FCC is 1.6 W/kg.
 - * Tests for SAR are conducted using standard operating positions accepted by the FCC with the device transmitting at its highest certified power level in all tested frequency bands. Although the SAR is determined at the highest certified power level, the actual SAR level of the device while operating can be well below the maximum value. This is because the device is designed to operate at multiple power levels so as to use only the power required to reach the network. In general, the closer you are to a wireless base station antenna, the lower the power output.
- The FCC has granted an Equipment Authorization for this device with all reported SAR levels evaluated as in compliance with the FCC RF exposure guidelines. SAR information on this device is on file with the FCC and can be found under the Display Grant section of www.fcc.gov/oet/ea/fccid after searching on FCC ID: ACJ9TGFZ-A12.

25-M-4

This product is restricted to indoor use due to its operation in the 5.15 to 5.25 GHz frequency range. FCC requires this product to be used indoors for the frequency range 5.15 to 5.25 GHz to reduce

the potential for harmful interference to co-channel Mobile Satellite systems. High power radars are allocated as primary users of the 5.25 to 5.35 GHz and 5.65 to 5.85 GHz bands. These radar stations can cause interference with and /or damage this product.

25-M-W-4

Responsible Party: Panasonic Corporation of North America

One Panasonic Way

Secaucus, NJ 07094

Tel No:1-800-LAPTOP5 (1-800-527-8675)

6-M-1

USA Only: Disposal may be regulated in your community due to environmental considerations. For disposal or recycling information, please visit Panasonic website:
<http://www.panasonic.com/environmental>
or call 1-888-769-0149

65-M-2

<For USA-California Only>

This product contains a CR Coin Cell Lithium Battery which contains Perchlorate Material - special handling may apply.
See www.dtsc.ca.gov/hazardouswaste/perchlorate/

38-M-1

CAUTION:

Risk of Explosion if Battery is replaced by an Incorrect Type.

Dispose of Used Batteries According to the Instructions.

58-E-1



A lithium ion battery that is recyclable powers the product you have purchased. Please call 1-800-8-BATTERY for information on how to recycle this battery.

48-M-1

For Canada

<Models for Canada>

Canadian ICES-003

CAN ICES-3(B)/NMB-3(B)

7-M-2

<Only for model with Wi-Fi/Bluetooth/GPS>

Industry Canada

This product complies with RSS210 Industry Canada.

Operation is subject to the following two conditions;

(1) this device may not cause interference, and

(2) this device must accept any interference,

including interference that may cause

undesired operation of the device.

30-Ca-1-1

This product (local network devices) for the band

5150- 5250 MHz is only indoor usage to reduce

potential for harmful interference to co-channel

Mobile Satellite systems. High power radars are

allocated as primary users (meaning they have

priority) of 5250-5350 MHz and 5650-5850 MHz

and these radars could cause interference and/or

damage to LELAN devices.

30-Ca-2-1

- This computer complies with Industry Canada radiation exposure limits set forth for an uncontrolled environment.
- This PC with WLAN and/or Bluetooth transmitters installed, has been approved for portable operation and does not require any minimum spacing be provided between antennas and all person's body.

25-Ca-1

FOR USE WITH MODEL NO. :

FZ-AA2202B

POUR UTILISER AVEC MODÈLE :

FZ-AA2202B

20-Ca-1

For Europe

<Only for model with a "CE" mark on the bottom of the computer>



Declaration of Conformity (DoC)

"Hereby, Panasonic declares that this

Personal Computer is

in compliance with the essential requirements and other relevant provisions of the Directive 1999/5/EC."

Hint:

If you want to get a copy of the original DoC of our above mentioned products, please contact our web address: <http://www.doc.panasonic.de>

Authorised Representative:

Panasonic Testing Centre

Panasonic Marketing Europe GmbH

Winsbergring 15, 22525 Hamburg, Germany

Regulatory Information

Indication of the countries where WLAN is intended to be used:

AT BE BG CH CY CZ DE DK EE ES
FI FR GB GR HU IE IS IT LT LU
LV MT NL NO PL PT RO SE SI SK TR

18-25-E-0

Interface Cable

Use of an interface cable longer than 3 m { 9.84 feet } is not recommended.

11-E-1

Regulations for Wireless LAN/Bluetooth

| Country / Region | 802.11a | 802.11b/g Bluetooth |
|--|--|---|
| Austria, Belgium, Croatia, Cyprus, Czech Republic, Denmark, Estonia, Finland, Germany, Greece, Hungary, Iceland, Ireland, Latvia, Lithuania, Luxembourg, Macedonia, Malta, Netherlands, Poland, Portugal, Slovakia, Slovenia, Spain, Sweden, Switzerland, United Kingdom | Restricted to indoor use. | |
| France | Restricted to indoor use. | Restricted to indoor use. |
| Italy | Restricted to indoor use. General authorization required if used outside. | General authorization required if used outside of own premises. |

| Country / Region | 802.11a | 802.11b/g Bluetooth |
|------------------|--|---|
| Turkey | Restricted to indoor use. Prohibited within an 1 km radius from the centre of the runway of the airports. | |
| Norway | Restricted to indoor use. | Prohibited within a 20 km radius from the centre of Ny-Ålesund. |

- The latest version of "ERC RECOMMENDATION 70-03" by European Radiocommunications Committee and the regulation in Turkey.
- Use only the antenna specified by Panasonic.
- Confirm the latest information to the radio regulation authorities.

40-E-1

For UK



<Models for UK>

For your safety, please read the following text carefully.

This appliance is supplied with a molded three pin mains plug for your safety and convenience.

A 3 ampere fuse is fitted in this plug.

Should the fuse need to be replaced please ensure that the replacement fuse has a rating of 3 ampere and that it is approved by ASTA or BSI to BS1362.

Check for the ASTA mark  or the BSI mark  on the body of the fuse.

If the plug contains a removable fuse cover you must ensure that it is refitted when the fuse is replaced.

If you lose the fuse cover the plug must not be used until a replacement cover is obtained. A replacement fuse cover can be purchased from your local dealer.

If the fitted molded plug is unsuitable for the socket outlet in your home then the fuse should be removed and the plug cut off and disposed of safely.

There is a danger of severe electrical shock if the cut off plug is inserted into any 13-ampere socket.

How to replace the fuse

The location of the fuse differs according to the type of AC mains plug (figures A and B).

Confirm the AC mains plug fitted and follow the instructions below. Illustrations may differ from actual AC mains plug.

Open the fuse cover with a screwdriver and replace the fuse and close or attach the fuse cover.

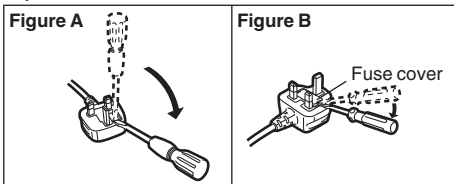

For India



For the purpose of recycling to facilitate effective utilization of resources, please return this product to a nearby authorized collection center, registered dismantler or recycler, or Panasonic service center when disposing of this product.

Please see the Panasonic website for further information on collection centers, etc.

<http://www.panasonic.co.in/wps/portal/home>

Introduction

Thank you for purchasing this Panasonic product. For optimum performance and safety, please read these instructions carefully.

Terms and Illustrations in These Instructions

➔ **Page in these Operating Instructions or in the Reference Manual.**

 **Reference to the on-screen manuals.**

- Some illustrations are simplified to help your understanding and may look different from the actual unit.
- Refer for the latest information about optional products to the catalogs, etc.

Disclaimer

Computer specifications and manuals are subject to change without notice. Panasonic Corporation assumes no liability for damage incurred directly or indirectly from errors, omissions or discrepancies between the computer and the manuals.

Trademarks / Licenses

- Google, the Google logo, Google Search, Gmail, Android and Google Play are trademarks of Google, Inc.
- Marvell and the Marvell logo are registered trademarks of Marvell and/or its affiliates.
- microSDHC Logo is a trademark of SD-3C, LLC.



- HDMI, the HDMI Logo and High-Definition Multimedia Interface are trademarks or registered trademarks of HDMI Licensing LLC in the United States and other countries.
- Adobe, the Adobe logo and Adobe Reader are either registered trademarks or trademarks of Adobe Systems Incorporated in the United States and/or other countries.
- Bluetooth® is a registered trademark owned by Bluetooth SIG, Inc., U.S.A. and licensed to Panasonic Corporation.
- Names of products, brands, etc., appearing in this manual are trademarks or registered trademarks of their respective own companies.
- This product is licensed under the AVC Patent Portfolio License, VC-1 Patent Portfolio License

and MPEG-4 Visual Patent Portfolio License for the personal use of a consumer or other uses in which it does not receive remuneration to (i) encode video in compliance with the AVC Standard, VC-1 Standard and MPEG-4 Visual Standard (“AVC/VC-1/MPEG-4 Video”) and/or (ii) decode AVC/VC-1/MPEG-4 Video that was encoded by a consumer engaged in a personal activity and/or was obtained from a video provider licensed to provide AVC/VC-1/MPEG-4 Video. No license is granted or shall be implied for any other use. Additional information may be obtained from MPEG LA, LLC. See <http://www.mpegla.com>.

Description of Parts

Front Side

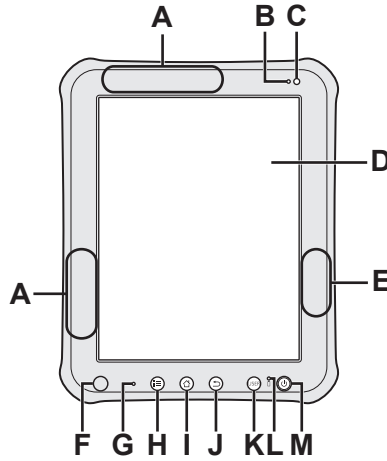

| | |
|----------|---|
| A | Wireless WAN Antenna <Only for model with wireless WAN> → <i>Reference Manual</i> "Wireless Communication - Wireless WAN" |
| B | Ambient light sensor → <i>Reference Manual</i> "Settings - Using Dashboard" |
| C | Front camera → <i>Reference Manual</i> "Photos and Videos" |
| D | LCD → "Input Operation" (page 19), "Home Screen" (page 20) |
| E | Wi-Fi antenna / Bluetooth antenna → <i>Reference Manual</i> "Wireless Communication - Wi-Fi", "Wireless Communication - Bluetooth" |
| F | Magnet sensor → <i>Reference Manual</i> "Settings - Using Settings Application - Display" |

| | |
|----------|--|
| G | Microphone → <i>Reference Manual</i> "Input Operation - Voice Input" |
| H | Menu button → "Input Operation" (page 19) |
| I | Home button → "Input Operation" (page 19) |
| J | Back button → "Input Operation" (page 19) |
| K | USER button → "Input Operation" (page 19) |
| L | Battery indicator → <i>Reference Manual</i> "Battery Power - Checking the Battery Status" |
| M | Power switch → "Turning On/Off and Sleeping/Waking Up" (page 18) |

Description of Parts

Rear Side

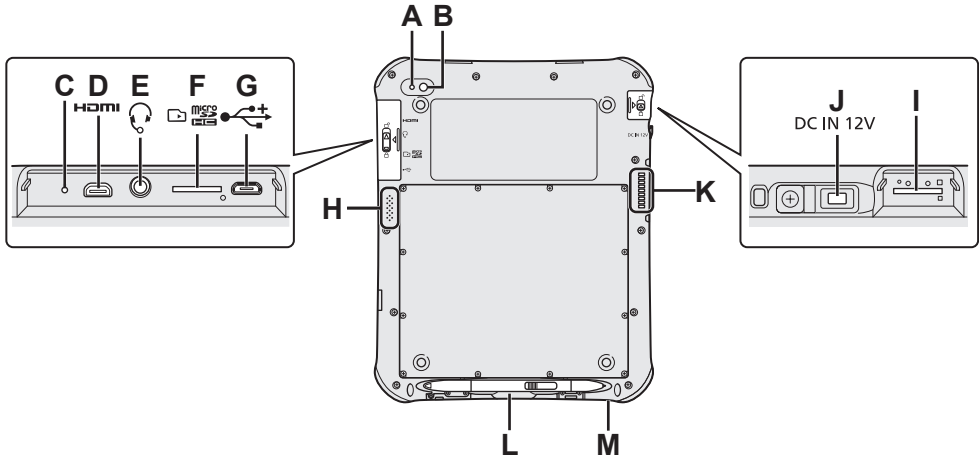

| | |
|----------|--|
| A | Camera light → <i>Reference Manual</i> "Photos and Videos" |
| B | Rear camera → <i>Reference Manual</i> "Photos and Videos" |
| C | Reset switch |
| D | HDMI Micro connector HDMI → <i>Reference Manual</i> "Connections - External Display" |
| E | Headphone/microphone jack |
| F | microSD memory card slot → <i>Reference Manual</i> "Connections - MicroSD Memory Card" |
| G | USB 2.0 Micro-B connector → <i>Reference Manual</i> "Connections - USB Connection" |
| H | Speaker |
| I | <Only for model with wireless WAN> SIM card slot → <i>Reference Manual</i> "Wireless Communication - Wireless WAN" |

| | |
|----------|--|
| J | DC-IN jack DC IN 12V |
| K | Expansion Bus Connector (Use as an extension in the future) |
| L | Pen holder (→ page 15) |
| M | Security lock A Kensington cable can be connected. For further information, read the manual that comes with the cable. |

CAUTION

When closing the DC-IN jack cover, push the cover straight. Otherwise, the cover may be damaged.

Correct

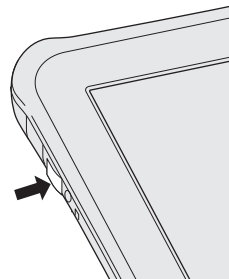

Incorrect

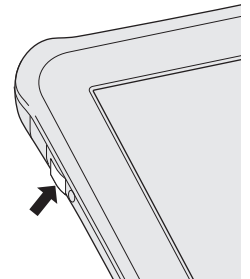

First-time Operation

Preparation

1 Check and identify the supplied accessories.

If you do not find the described accessories, contact your technical support office.

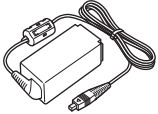

AC Adaptor...1
Model No.
FZ-AA2202B

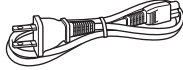

AC Cord...1
(Shape depends on
the country)

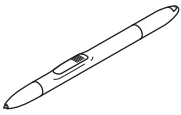

Digitizer Pen...1
(At the time of
purchase, the digitizer
pen is put in the pen
holder (→ page 14).)

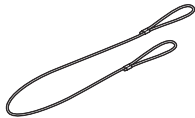

Tether...1



Soft Cloth...1
OPERATING INSTRUCTIONS
(This book)...1

2 To prevent the digitizer pen falling accidentally, attach the digitizer pen to this computer using the tether.

1. Pass one of the loops through the hole of the digitizer pen.

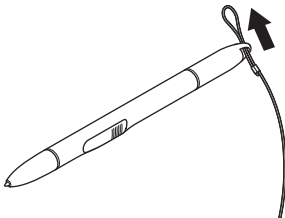

2. Pass one of the loops through the second loop on the tether.

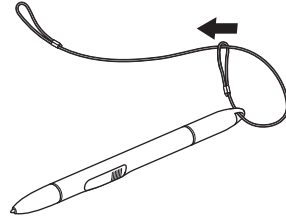

3. Thread the second loop on the tether to the hole as illustrated.

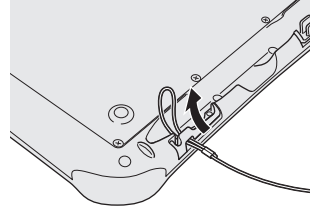

4. Pass the digitizer pen through the second loop on the tether as illustrated.

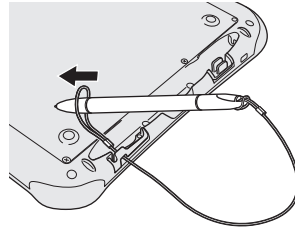

NOTE

- When the digitizer pen is not used, hook the tether as illustrated.

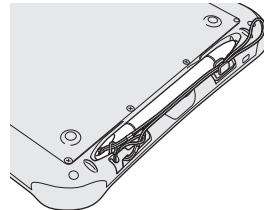

First-time Operation

Starting Up

1 Connect this computer to a power outlet.

The battery charging starts automatically.

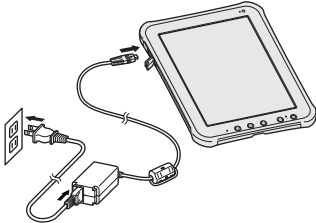

CAUTION

- Do not disconnect the AC adaptor until the first-time operation procedure is completed.
- When using this computer for the first time, do not connect any peripheral device except the AC adaptor.
- Handling the AC adaptor
 - Problems such as sudden voltage drops may arise during periods of thunder and lightning. Since this could adversely affect this computer, an uninterruptible power source (UPS) is highly recommended unless running from the battery alone.

2 Press (Power switch).

After the battery indicator blinks 3 times, this tablet computer starts up.

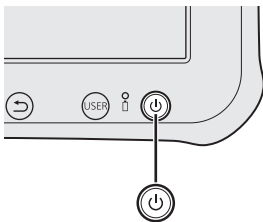

3 If necessary, touch the language name and scroll the language list, then touch the language you use.

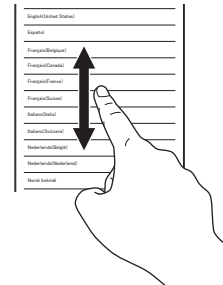

4 Touch [Start].

<Only for model with wireless WAN>

If “SIM card not found” is displayed, touch [Skip]. Then touch [Skip] or configure wi-fi settings by following the on-screen instructions.

5 Touch and scroll the time zone list and touch the time zone for your location.

If necessary, set date and time or set [Automatic date & time] to [ON].

6 Touch [Next].

“Sign in with your Google Account” screen is displayed.

7 If necessary, set up your Google account by following the on-screen instructions.

- If you set up your Google account, you can use Gmail, Calendar, etc.

8 When “Use Google location” is displayed, touch the Google location services to enable/disable them, and touch [Next].



9 When “This tablet belongs to...” is displayed, input your name and touch [Next].

10 Read “Google services” and touch [Next].

11 When “Setup complete” is displayed, touch [Finish].

12 When “Make yourself at home” is displayed, touch [OK].

13 Connect to internet via Wi-Fi or wireless WAN.

14 Touch  - [ Settings] - [ About tablet] - [System Updates] - [Software Update].

15 When message “System Software Update is going to check the latest firmware package. Continue?” is displayed, touch [Yes].

16 If message “A new software update package is available...” is displayed, touch [Yes].

Wait a few minutes for the download to complete.

If message “The current system software is up-to-date” is displayed, touch [OK] to finish.

There is not an updated system software available.

17 When message “Ready to update your device...” is displayed, touch [Update Now].

18 Touch [OK] to automatically reboot the system and start update process.

Wait a few minutes for the update to complete. After update is completed, the system will boot up automatically.

19 When message “System Software has been successfully update.” is displayed, touch [OK].

Turning On/Off and Sleeping/Waking Up

Turning On

1 Press  (Power switch).

2 Drag  to  or .

When dragging  to , Camera application will start.

CAUTION

- Do not press the power switch repeatedly.
- Once you turn off this computer, wait for 10 seconds or more before you turn it on again.
- Do not perform the following operation until the home screen is displayed.
 - Connecting or disconnecting the AC adaptor
 - Pressing the power switch
 - Touching the screen or buttons

Turning Off

1 Press and hold  (Power switch) until “Power off” screen is displayed.

2 Touch “OK”.



Sleeping

At the time of purchase, the screen turns off automatically after 1 minute with no operation. To turn off the screen manually, perform the following operation.

1 Press  (Power switch).

The screen turns off.

NOTE

- The screen turns off automatically after 1 minute. You can change time to turn the screen off by touching  - [ Settings] - [ Display] - [Sleep].

Waking Up

1 Press  (Power switch).

The lock screen is displayed.

2 Drag  to  or .

When dragging  to , Camera application will start.

NOTE

- Some applications (“Clock” etc.) will appear before the lock screen is displayed. After that application is closed, the lock screen is displayed.

Input Operation

Screen Input Operation

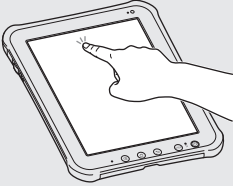
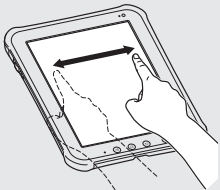
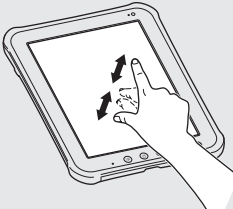
| | |
|---|---|
| Touch  | Select items or options. |
| Touch and hold | Open special options. |
| Drag | Scroll the screen. |
| Flick  | Scroll the screen quickly. |
| Drag and drop | Move an item. |
| Pinch  | Zoom in or out the screen. Depending on the applications, you can also zoom in or out by double-touching the screen. |

Using the Digitizer Pen

You can operate “Touch”, “Touch and hold”, “Drag”, “Flick”, “Drag and drop” and “Double-tap” by using the included digitizer pen instead of your finger.

- Without pressing the digitizer button (A):
Touch the screen with the digitizer pen.
- While pressing the digitizer button (A):
Close the digitizer pen to the screen.

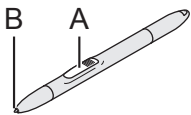



CAUTION

- The tip of the digitizer pen (B) is equipped with a sensor. Continued applied pressure to the tip may result in its malfunction or degradation. Make sure excessive pressure is not applied to the tip when storing the digitizer pen.











Digitizer Calibration

If necessary, perform the digitizer calibration by following steps below.

Perform the calibration for the orientation to be used.

- 1 Touch  - [ Pen Calibration].
- 2 Using the digitizer pen, touch each target  one by one.
- 3 Touch [Finished].

Buttons

| | |
|---|---|
|  | Select additional functions. The same function as []. |
|  | Return to the home screen. The same function as []. |
|  | Return to the previous screen. The same function as []. |
|  | <ul style="list-style-type: none"> ● Press within 1 second : Enter security mode (sound off, screen off and lock). To return from security mode, press  (Power switch). ● Press for more than 1 second : Launch “Dashboard”. ● Press and hold  (USER button), then press  (Menu button) within 1 second: Take screenshot The screenshot data will be stored in the following folder. /sdcard/Pictures/Screenshots/ |

Input Operation

Home Screen

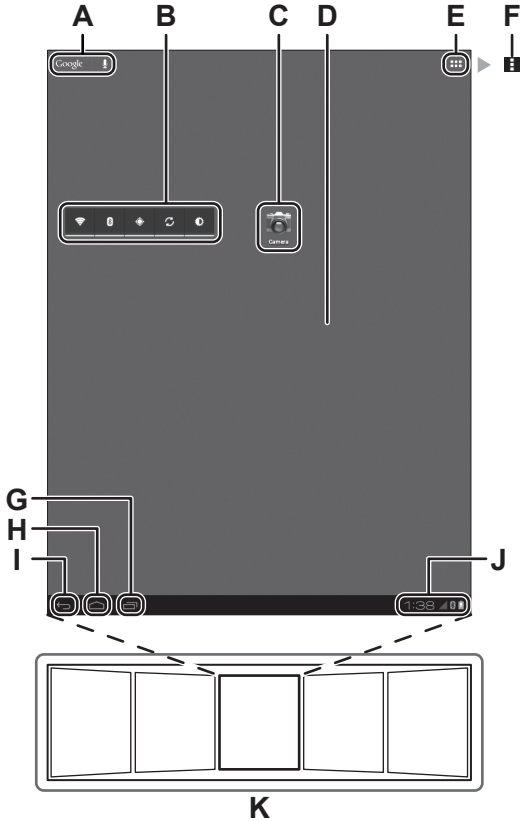

- A** **Search / Voice search**
Search the internet and this computer using Google search. You can input the search terms by using on-screen keyboard or speaking.
- B** **Widgets**
The small applications on the home screen. Some widgets display the latest information (clock, calendar, weather, email, etc.) on the home screen.
- C** **Application shortcuts**
Open an application. You can add/remove applications shortcuts to/from the home screen.
- D** **Home screen**
The starting point for this computer. You can place shortcuts, widgets and other items to the home screen.
- E** **Apps**
Display all applications and widgets. Touch an application/widget to open from the list.

- F** **Menu**
Depending on the applications, is displayed at the top-right of the screen. You can select additional functions from the menu.
- G** **Recent apps**
Display the recent applications. Touch an application to open from the application list. To stop the application, drag it to the right.
- H** **Home**
Return to the home screen.
- I** **Back**
Return to the previous screen.
- J** **Status detail and quick settings**
Touch this area to open the status detail (notification icons, status icons and clock) ([Reference Manual](#) “Home Screen - Notification Icons”, “Home Screen - Status Icons”). Touch the status detail to open the quick settings. The quick settings display network status, remaining battery charge and other details.
When you touch [Settings], Settings application is opened.

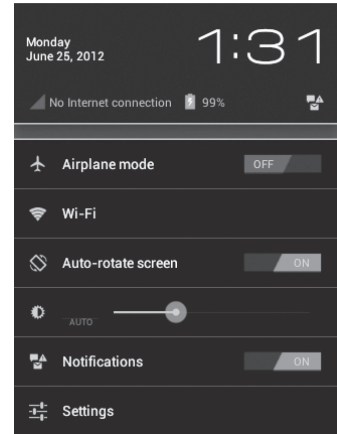

- K** **Panels**
This computer has 5 panels. Flick left or right to display the next panel.

Handling and Maintenance

Operation Environment

- Place this computer on a flat stable surface. If this computer is exposed to an extremely strong impact, it may become damaged.
- Temperature :
 - Operation : -10 °C to 50 °C {14 °F to 122 °F} (IEC60068-2-1, 2)*¹
 - Storage : -20 °C to 60 °C {4 °F to 140 °F}
- Humidity :
 - Operation : 30 % to 80 % RH (No condensation)
 - Storage : 30 % to 90 % RH (No condensation)

Even within the above temperature/humidity ranges, using for a long time in an extreme environment will result in the product deterioration and will shorten the product life. If this computer is wet in temperatures of 0 °C or below, freeze damage may occur. Make sure to dry off this computer in such temperatures.

*¹ Do not expose the skin to this product when using the product in a hot or cold environment. (→ page 4)

- Do not place this computer in the following areas, otherwise the computer may be damaged.
 - Near electronic equipment. Image distortion or noise may occur.
 - In extremely high or low temperature.
- As this computer can become hot during operation, keep it away from items that are sensitive to heat.

Handling Cautions

This computer is designed to minimize shock to parts such as the LCD and the flash memory drive, but no warranty is provided against any trouble caused by shock. Be extremely careful when handling this computer.

- When carrying this computer :
 - Turn off this computer.
 - Remove all external devices, cables and other protruding objects.
 - Do not drop or hit this computer against solid objects.
 - Do not grip the display part.
- When you board an airplane, take this computer with you and never put it in your checked luggage. When using this computer on airplane, follow the airline's instructions.
- Use only the included digitizer pen or finger to touch the screen. Do not place any object on its surface and do not press down strongly with

sharp-pointed or hard objects that may leave marks (e.g., nails, pencils and ball point pens).

- Do not use the screen when dust or dirt (e.g., oil) is on the screen. Otherwise foreign particles on the screen/digitizer pen can scratch the screen surface or obstruct the digitizer pen operation.
- Use the digitizer pen only for touching the screen. Using it for any other purpose may damage the digitizer pen and result in scratches on the screen.

When Using Peripheral Devices

Follow these instructions and the Reference Manual to avoid any damage to the devices. Carefully read the instruction manuals of the peripheral devices.

- Use the peripheral devices conforming to this computer's specifications.
- Connect to the connectors in the correct direction.
- If it is hard to insert, do not try forcibly but check this computer's shape, direction, alignment of pins, etc.
- Remove the cables when you carry this computer. Do not pull the cables forcibly.

Preventing This Computer from Unauthorized Use via Wireless Networks

- Before using Wi-Fi/Bluetooth/wireless WAN*², make the appropriate security settings such as data encryption.

*² Only for model with wireless WAN.

Maintenance

To Clean the LCD Panel

- When the screen becomes dirty, wipe it with an approved soft cloth.
The screen is specially treated to prevent dirt from adhering to the surface, so dirt can be removed easily using a dry cloth (use only the approved soft cloth).
Remove the dirt, water, etc. as soon as possible. Otherwise, the LCD panel is stained or changes in quality.
If the dirt does not come off easily, breathe on the surface and try again.
- Suggestions About Cleaning the LCD Surface
To improve the outdoor visibility of the display, a low reflection coating has been added. In order

Handling and Maintenance

to avoid scratches and peeling of this coating, an approved soft cloth has been included to wipe the LCD surface of this computer. Before using this computer, be sure to read the instructions provided below.

- Be sure to wipe the LCD display to remove fingerprints, etc., with the soft cloth.
- Do not wipe areas other than the LCD display with the soft cloth.

How to use the soft cloth

- Use the soft cloth when it is dry. Do not apply water or solvents to the soft cloth.
- First, lightly wipe foreign particles and dust adhering to the LCD display on one side of the soft cloth. Do not use force, since the LCD surface may be damaged with the foreign particles or dust.

Next, wipe off fingerprint, etc., with the other side of the soft cloth.

After wiping off foreign particles and dust, wash the soft cloth (refer to the following) to remove the foreign particles and dust from the soft cloth.

- Clean the screen while the computer is powered off.
Cleaning the screen while the power is on may cause the computer to malfunction. Also, dirt on the screen is easier to see when the computer is powered off, and so is easier to clean.
- Wash the soft cloth when it becomes dirty.
When the soft cloth becomes dirty, wash it with mild detergent. Do not use bleach or fabric conditioner (softener), or try to sterilize the cloth by boiling.
If the soft cloth is dirty, it may be ineffective in cleaning the screen, and in fact may cause dirt to adhere to the screen.
- Check the following to prevent the surface of the screen from being scratched.
 - Are you using your finger or a digitizer pen to operate the screen?
 - Is the surface clean?
 - Is the soft cloth clean?
 - Are you using the digitizer pen with the tip extended?
 - Is the tip of the digitizer pen clean?
 - Is your finger clean?



To Clean Areas Other Than the LCD Panel

Wipe with a soft dry cloth such as gauze. When using detergent, dip a soft cloth in water-diluted detergent and wring it thoroughly.

CAUTION

- Do not use benzene, thinner, or rubbing alcohol since it may adversely affect the surface causing discoloration, etc. Do not use commercially-available household cleaners and cosmetics, as they may contain components harmful to the surface.
- Do not apply water or detergent directly to the computer, since liquid may enter inside of the computer and cause malfunction or damage.

Encrypting Tablet

Before enabling "Encrypt tablet" by touching  - [ Security] - [Encrypt tablet], backup your data. If a trouble occurs while encrypting, data on this computer will be erased.

Dispose of Computer

- Remove the microSD memory card and other peripherals.
- Perform "Factory data reset" to erase the stored data. (→ page 26)
- After the remaining battery charge become 0 %, remove the battery by performing the following steps, and dispose or recycle the battery in accordance with national legislation.



DANGER

Generation of heat, ignition or rupture of the battery may result.



Handling This Computer

- Do Not Disassemble the Computer Except When Disposing of It

Handling The Battery

- Do Not Charge
- Do Not Use With Any Other Product
- Do Not Throw the Battery Into a Fire or Expose It to Excessive Heat
- Avoid Extreme Heat (Near the Fire, In Direct Sunlight, for Example)
- Do Not Short the Positive (+) and Negative (-) Contacts
- Do Not Insert Sharp Objects Into the Battery, Disassemble, or Modify It
- Do Not Apply Shocks to the Computer by Dropping It, Applying Strong Pressure to It, etc.

- 1 Remove 12 screws of the battery cover and remove the cover.**

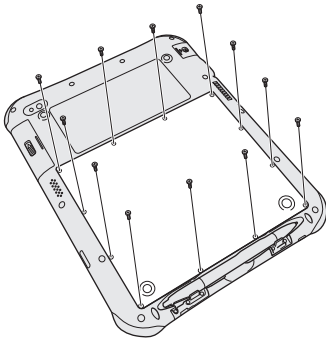

- 2 Peel off the clear sheet as illustrated below.**

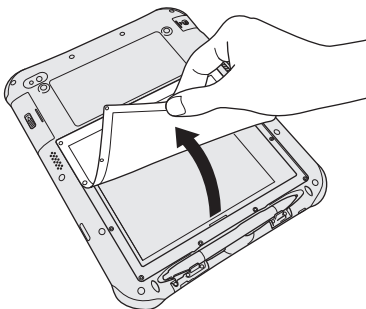

- 3 Lift up and slightly pull the battery.**

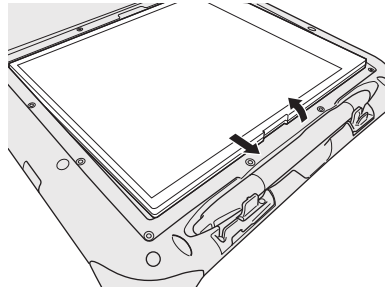

- 4 Pull the cable to disconnect the connector.**

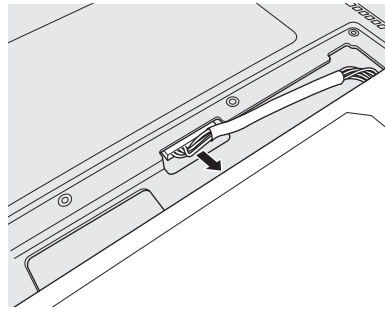





- 5 Insulate the terminals of the connector with plastic tape, etc.**

Troubleshooting (Basic)

Follow the instructions below when a problem has occurred. There is also an advanced troubleshooting guide in the “Reference Manual”. For a software problem, refer to the software’s instruction manual. If the problem persists, contact Panasonic Technical Support.

Starting Up

| | |
|---|--|
| Cannot start up. The battery indicator is not lit. | <ul style="list-style-type: none">● Connect the AC adaptor.● If the remaining battery charge is 5 % or less and the AC adaptor is not connected, when the power switch is pressed, the battery indicator lights red and this computer does not start. Charge the battery.● Remove the AC adaptor, then connect it again.● Press and hold  (Power switch) until the battery indicator blinks 3 times. |
| Cannot turn on this computer. This computer does not wake up from sleep. | <ul style="list-style-type: none">● This computer may become too hot or too cold. Leave it in an environment of 5 °C {41 °F} to 35 °C {95 °F} for about an hour, then turn on the power again. |
| The date and time are incorrect. | <ul style="list-style-type: none">● Make the correct settings by performing the following steps. 1. Touch  - [ Settings] - [ Date & time], and set date and time.● If the problem persists, the internal clock battery may need to be replaced. Contact Panasonic Technical Support.● When this computer is connected to network, check the date and time of the server.● The 2036 A.D. or later year will not be correctly recognized on this tablet computer. |
| Operation is slow. | <ul style="list-style-type: none">● Ambient temperature may be high. Move this computer to the cooler location. |
| Cannot wake up. | <ul style="list-style-type: none">● You disconnected the AC adaptor while this computer was in sleep. If this computer’s power supply is disconnected in sleep and the battery is exhausted, unsaved data will be lost and this computer will not wake up. |
| Other startup problems | <ul style="list-style-type: none">● Remove all peripheral devices. |

Shutting Down

| | |
|--|---|
| This computer does not shut down. | <ul style="list-style-type: none">● Wait one or two minutes. It is not a malfunction.● Press and hold  (Power switch) for 8 seconds or longer to turn the computer off forcibly.● Remove all peripherals from this computer. |
|--|---|

Display

| | |
|---|---|
| No display | <ul style="list-style-type: none"> ● The computer entered sleep by the power-saving function. To resume, To wake it up, press  (Power switch). |
| The screen is dark. | <ul style="list-style-type: none"> ● If the brightness setting of this computer is set to “Automatic brightness”, the screen brightness automatically changes depending on the ambient brightness. Disable “Automatic brightness” and change the brightness of the screen. |
| The screen is disordered. | <ul style="list-style-type: none"> ● Connecting/disconnecting an external display may affect the screen. Restart this computer. |
| The external display does not display. | <ul style="list-style-type: none"> ● Check the cable connection. ● Turn on the display. |
| The external display does not work normally. | <ul style="list-style-type: none"> ● If the external display does not support the power saving function, it may not work normally when this computer enters the power saving mode. Turn off the external display. |
| There are red, green, or blue dots on the screen, or there is unevenness in colors and brightness on the screen. | <p>The following are not malfunctions.</p> <ul style="list-style-type: none"> ● Although advanced high-precision technologies are used in the production of color LCD screens, 0.002 % or less of the picture elements may be dark or remain constantly lit (i.e., more than 99.998 % of elements function properly). ● Due to the natural characteristics of LCD screens, you may notice unevenness in colors and brightness depending on your angle of view. Hues may also vary by product. |

Screen Operation

| | |
|---|--|
| Cannot point the correct position. | <ul style="list-style-type: none"> ● Perform the digitizer calibration (→ page 19). |
|---|--|

Battery Indicator

| | |
|-------------------------|--|
| Blinking orange. | <ul style="list-style-type: none"> ● The battery cannot be charged temporarily. Remove the AC adaptor, then connect it again. |
| Lighting red. | <ul style="list-style-type: none"> ● The remaining battery charge is approximately 5 % or less. Charge the battery. |





On-Screen Manual

| | |
|---|--|
| When the screen is rotated, part of the screen is not displayed. | <ul style="list-style-type: none"> ● If the screen is zoomed or the menu is opened, zoom out and close the menu, then touch  to reload the data. |
|---|--|

Troubleshooting (Basic)

Others

No response



- Press and hold  (Power switch) until “Power off” screen is displayed and touch [OK], then press  (Power switch) to turn it on.
- If the application does not work normally, uninstall and reinstall the application. To uninstall :
 1. Touch  - [ Settings] - [ Apps].
 2. Touch [DOWNLOADED] or [ALL], and touch the application to uninstall, then touch [Uninstall].
 3. Uninstall the application by following the on-screen instructions.

Factory Data Reset

CAUTION

- Factory data reset function will return this computer to the default condition. When you reset this computer, the stored data will be erased.

Back up important data to other media before reset.

1. Touch  - [ Settings] - [ Backup & reset] - [Factory data reset].
All the data in /mnt/sdcard folder will be erased. The data in microSD memory card inserted into microSD memory card slot will not be erased.
2. Touch [Reset tablet].
3. Follow the on-screen instructions.

Specifications

Main Specifications

| | | | |
|---------------------------------|----------------------------|--|--|
| Model No. | | FZ-A1 series | |
| CPU/Secondary cache memory | | Marvell PXA2128, Dual Core CPU, 1.20 GHz | |
| Main Memory | | 1 GB*1 | |
| Storage | | 16 GB*2 (Flash memory) | |
| Display Method | | 10.1 type (TFT) (1024 × 768 dots) | |
| Touchscreen | | Multi-touch screen and digitizer | |
| Wi-Fi | | IEEE 802.11 a/b/g/n | |
| Bluetooth*3 | | v 2.1 +EDR | |
| Wireless WAN*4 | | 3G/LTE module | |
| GPS | | built-in | |
| Card Slots | microSD Memory Card Slot*5 | microSDHC compatible × 1 | |
| | SIM Card Slot | × 1*4 | |
| Interface | | USB 2.0 Micro-B connector × 1*6 / HDMI Micro connector*7 / Microphone & Headphone Jack / Expansion Bus Connector (Use as an extension in the future) | |
| Camera | | Front: 2.0 Mega pixel, fixed focus Rear: 5.0 Mega pixel with LED flash, auto focus | |
| Sensor | | Digital Compass, Accelerometer, Ambient light sensor | |
| Power Supply | | AC adaptor or internal battery | |
| AC Adaptor*8 | | Input: 100 V - 240 V AC, 50 Hz/60 Hz Output: 12 V DC, 2 A | |
| Battery | | Li-ion 7.4 V, Typical 4770 mAh / Minimum 4590 mAh | |
| | | Operating Time*9 | |
| | | Charging Time*10 | |
| Physical Dimensions (W × D × H) | | 266.3 mm × 17.5 mm × 212.0 mm {10.5" × 0.7" × 8.4"} | |
| Weight | | Approx. 0.993 kg {2.19 lb.} | |
| Environment | Operating | Temperature | -10 °C to 50 °C {14 °F to 122 °F} (IEC60068-2-1, 2)*11 |
| | | Humidity | 30 to 80 % RH (No condensation) |
| | Storage | Temperature | - 20 °C to 60 °C {4 °F to 140 °F} |
| | | Humidity | 30 % to 90 % RH (No condensation) |
| OS*12 | | Android 4.0 (Ice Cream Sandwich) | |
| Pre-installed Software | | Adobe Reader, AuthenTec QuickSec, Dashboard, Device Management, McAfee Mobile Security (Trial version), Pen Calibration, Google applications*13 | |

- Approx. 0.9 W of power is consumed when the battery is fully charged (or not being charged) and this computer is off.
Even when the AC adaptor is not connected to this computer, max. 0.3 W of power is consumed simply by having the AC adaptor plugged into an AC outlet.

*1 1 GB = 1,073,741,824 bytes

*2 1 GB = 1,000,000,000 bytes. Your operating system or some application will report as fewer GB. Approx. 3 GB*1 is used as system area.



*3 Does not guarantee operation of all bluetooth peripherals.

Specifications

- *4 Only for model with wireless WAN.
- *5 This slot is compatible with High-Speed Mode. Operation has been tested and confirmed using Panasonic microSD/microSDHC Memory Cards with a capacity of up to 32 GB. Operation on other SD equipment is not guaranteed.
- *6 Does not guarantee operation of all USB-compatible peripherals.
- *7 Does not guarantee operation of all HDMI-compatible peripherals.
- *8 <Only for North America>
The AC adaptor is compatible with power sources up to 240 V AC adaptor. This computer is supplied with a 125 V AC compatible AC cord.20-M-2-1
- *9 Measured with LCD brightness : 60 cd/m² Varies depending on the usage conditions, or when an optional device is attached.
- *10 Varies depending on the usage conditions, CPU speed, etc.
- *11 Do not expose the skin to this product when using the product in a hot or cold environment. (→ page 4)
When using in hot or cold environment, some peripherals may fail to work properly. Check the operation environment of the peripherals.
Using this product continuously in a hot environment will shorten the product life. Avoid use in these types of environments.
When using in low temperature environment, startup may become slow or battery operation time may become short. Therefore, if you are using battery power and the remaining power is low, this computer may not start up.
- *12 An OS that has been installed at the time of purchase can be supported.
- *13 Depending on the model, some Google applications may be installed.

This product incorporates the following software:

- (1) the software developed independently by or for Panasonic Corporation,
- (2) the software owned by third party and licensed to Panasonic Corporation,
- (3) the software licensed under the GNU General Public License, Version 2.0 (GPL V2.0),
- (4) the software licensed under the GNU LESSER General Public License, Version 2.1 (LGPL V2.1) and/or,
- (5) open source software other than the software licensed under the GPL V2.0 and/or LGPL V2.1.

The software categorized as (3) - (5) are distributed in the hope that it will be useful, but WITHOUT ANY WARRANTY, without even the implied warranty of MERCHANTABILITY or FITNESS FOR A PARTICULAR PURPOSE. Please refer to the detailed terms and conditions thereof displayed by touching  - [ Settings] - [ About tablet] - [Legal information] - [Open source licenses] from the Home screen.

At least three (3) years from delivery of products, Panasonic will give to any third party who contacts us at the contact information provided below, for a charge no more than our cost of physically performing source code distribution, a complete machine-readable copy of the corresponding source code covered under GPL V2.0, LGPL V2.1 or the other licenses with the obligation to do so as well as the respective copyright notice thereof.

Contact Information: oss-cd-request@gg.jp.panasonic.com

The source code and the copyright notice are also freely available to you via our website below.
<http://panasonic.net/avc/oss/index.html>

About the terms and conditions of GPL V2.0 and LGPL V2.1, please refer to the "Reference Manual" of this computer.







Panasonic Corporation

Osaka, Japan

Panasonic System Communications Company of North America

3 Panasonic Way, Panazip 2F-5,
Secaucus, NJ 07094

Panasonic Canada Inc.

5770 Ambler Drive, Mississauga,
Ontario L4W 2T3

Importer's name & address pursuant to the EU legislation

Panasonic System Communications Company Europe, Panasonic Marketing Europe GmbH

Hagenauer Straße 43
65203 Wiesbaden
Germany

Web Site : <http://panasonic.net/>

パナソニック株式会社 ITプロダクツビジネスユニット
〒570-0021 大阪府守口市八雲東町一丁目10番12号